

COUNTY GOVERNMENT OF BUNGOMA



**DEPARTMENT OF ROADS, INFRASTRUCTURE AND
PUBLIC WORKS**

TENDER NO. BGM/CNTY/RPW/CEF/OT/ 075/2025/2026.

**ROAD NAME: PERIODIC MAINTENANCE OF ROADS IN NAMWELA
WARD**

MAY 2026

CHIEF OFFICER

**ROADS, INFRASTRUCTURE AND
PUBLIC WORKS**

P.O BOX 437 – 50200

BUNGOMA

CEC MEMBER

**ROADS, INFRASTRUCTURE AND
PUBLIC WORKS**

P.O BOX 437 – 50200

BUNGOMA

Table of Contents

INVITATION TO TENDER.....	6
PART 1 – TENDERING PROCEDURES	11
SECTION I - INSTRUCTIONS TO TENDERERS	12
A. GENERALPROVISIONS	12
1.0 Scope of Tender.....	12
2.0 Fraud and Corruption	12
3.0 Eligible Tenderers	12
4.0 Eligible Goods, Equipment, and Services	16
5.0 Tenderer's Responsibilities	16
B. CONTENTS OF TENDER DOCUMENTS.....	17
6.0 Sections of Tender Document.....	17
7.0 Clarification of Tender Document, Site Visit, Pre-Tender Meeting.....	17
8.0 Amendment of Tender Documents	18
C. PREPARATION OF TENDERS.....	19
9.0 Cost of Tendering	19
10.0 Language of Tender	19
11.0 Documents Comprising the Tender	19
12.0 Form of Tender and Schedules	20
13.0 Alternative Tenders.....	20
14.0 Tender Prices and Discounts.....	21
15.0 Currencies of Tender and Payment	22
16.0 Documents Comprising the Technical Proposal	22
17.0 Documents Establishing the Eligibility and Qualifications of the Tenderer	22
18.0 Period of Validity of Tenders.....	23
19.0 Tender Security	24
20.0 Format and Signing of Tender	26
D. SUBMISSION AND OPENING OF TENDERS.....	26

21.0	Sealing and Marking of Tenders.....	26
22.0	Deadline for Submission of Tenders.....	27
23.0	Late Tenders	27
24.0	Withdrawal, Substitution, and Modification of Tenders.....	27
25.0	Tender Opening	28
E.	Evaluation and Comparison of Tenders.....	29
26.0	Confidentiality	29
27.0	Clarification of Tenders	29
28.0	Deviations, Reservations, and Omissions.....	30
29.0	Determination of Responsiveness	30
30.0	Non-material Non-conformities	30
31.0	Arithmetical Errors.....	31
32.0	Conversion to Single Currency.....	31
33.0	Margin of Preference and Reservations.....	31
34.0	Nominated Subcontractors	32
35.0	Evaluation of Tenders.....	32
36.0	Comparison of Tenders.....	33
37.0	Abnormally Low Tenders and Abnormally High Tenders.....	33
	Abnormally Low Tenders.....	Error! Bookmark not defined.
39.0	Qualifications of the Tenderer.....	34
40.0	Lowest Evaluated Tender	35
41.0	Procuring Entity's Right to Accept Any Tender, and to Reject Any or All Tenders.....	35
F.	AWARD OF CONTRACT	35
42.0	Award Criteria.....	35
43.0	Notice of Intention to enter into a Contract.....	35
44.0	Stand still Period.....	36
45.0	Debriefing by the Procuring Entity	36
46.0	Letter of Award	36

47.0	Signing of Contract.....	36
48.0	Performance Security	36
49.0	Publication of Procurement Contract	37
50.0	Procurement Related Complaint.....	37
SECTION III - TENDER DATA SHEET (TDS)		38
SECTION IV- EVALUATION AND QUALIFICATION CRITERIA.....		42
General Provisions.....		42
1.0	General Provisions.....	42
2.0	Preliminary examination for Determination of Responsiveness	42
3.0	Tender Evaluation (ITT 35).....	43
4.0	Multiple Contracts	43
5.0	Alternative Tenders (ITT 13.1)	44
6.0	Margin of Preference.....	44
7.0	Post qualification and Contract award (ITT 39), more specifically,	44
3.	FORM EQU: EQUIPMENT	59
SELF DECLARATION THAT THE PERSON/TENDERER IS NOT DEBARRED IN THE MATTER OF THE PUBLIC PROCUREMENT AND ASSET DISPOSAL ACT 2015.....		90
FORM OF TENDER SECURITY - DEMAND BANK GUARANTEE.....		98
1003	Excavation of Gravel.....	138
1006	Carriageway Grading.....	141
1007	Restoration of Quarries and Borrow pits.....	142
1703	MATERIALS FOR CONCRETE	143
1703(A)	LEVELLING CONCRETE (CLASS 15/20) FOR BOTTOM SLAB INCLUSIVE OF COST OF FORM WORKS	144
1703 (C)	FORMWORK FOR CULVERT WALLS.....	144
1703(D)	CONCRETE WORKS (CLASS 20/20).....	145
2001	ROAD RESERVE BOUNDARY POSTS	150
2003	EDGE MARKER POST.....	151

2004B EXISTING ROAD SIGNS 151

2005 ROAD MARKING..... 151

2005A RAISED PAVEMENT MARKERS – ROAD STUDS MATERIAL 151

REQUIREMENTS 152

ADHESIVES..... 152

APPLICATION INSTRUCTION 153

2006 GUARDRAILS 153

2007 KERBS 154

2008 EDGE MARKER POSTS 154

2010 BOLLARDS 154

2011 MEASUREMENT AND PAYMENT 154

2202 MEASUREMENTS AND PAYMENT..... 155

SECTION 23: CONCRETE PAVING BLOCKS 155

c. Measurement and Payment..... 156

INVITATION TO TENDER

**PROCURING ENTITY: COUNTY GOVERNMENT OF BUNGOMA, P.O BOX 437-50200
BUNGOMA.**

**CONTRACT NAME: PERIODIC MAINTENANCE OF ROADS IN NAMWELA WARD,
TENDER NO. BGM / CNTY / RPW / CEF/OT / 075 / 2025 - 2026**

1. The County Government of Bungoma through Department of Roads, Infrastructure and Public Works Wishes to invites sealed tenders for the Periodic Maintenance of Roads in Namwela Ward.
2. Tendering will be conducted under Open National competitive method using a standardized tender document. Tendering is open to all qualified and interested Tenderers.
3. Qualified and interested tenderers may obtain further information and inspect the Tender Documents at Supply Chain Management Office located behind H.E the Governor 's office County Government of Bungoma for assistance during official working hours. (Monday-Friday 8:00am-5:00Pm).
4. Interested eligible candidates may download a complete set of tender document with evaluation criteria from the County Government of Bungoma website www.bungoma.go.ke and/or Public Procurement Information portal: www.tenders.go.ke.
5. Complete tender document must be submitted manually through the Tender Box Located at the County Headquarters at the Supplier Chain Management office opposite Municipal Building so as to be received on or before **Thursday 28th May 2026 at 11.00 A.M.**
6. Tenders will be opened immediately after the deadline date and time specified above or any deadline date and time specified later. Tenders will be publicly opened in the presence of the Tenderers' designated representatives who choose to attend at the address below.
7. Prices quoted should be inclusive of all taxes and must be in Kenya shillings and shall remain valid for a period of **90 days** from the closing date.

Mandatory requirements

- 1) Certified Copy of Certificate of registration/incorporation.
- 2) Copy of valid tax compliance certificate/exemption certificate issued by KRA
- 3) Copy of CR 12 certificate for limited Companies. Should be recent (within 6 months)
- 4) Valid copy of Certificate of registration with the National Construction Authority for Road works; **NCA 8 and above and MUST** be accompanied by a valid annual practicing License.
- 5) KRA PIN/VAT certificate issued by KRA
- 6) Bid security of **Kshs. 100,000/=** from reputable bank or Insurance Company approved by PPRA.
- 7) Dully filled, signed and stamped Tender form
- 8) Dully filled, stamped and signed Business Questionnaire Form
- 9) Dully filled, signed and stamped bills of quantities
- 10) Certified Single Business Permit from any County Government Authority
- 11) **MUST** provide Copies of the national ID/passport for the directors as per CR12

**DINAH MAKOKHA
CHIEF OFFICER
DEPARTMENT OF ROADS, INFRASTRUCTURE AND PUBLIC WORKS.**

TECHNICAL EVALUATION CRITERIA

ITEM	DESCRIPTION		POINT SCORE SCALE	
1	History of Non - Performance		Max 5	
2	KEY PERSONNEL		Max 30	
	Site Agent (Max 14 marks)	Qualification	Bsc Civil Engineering.	8
			Registered Engineer	3
			HND in Civil Eng.	4
			Dip in Civil Eng.	3
		Experience	> 8 years and above	3
			3-7 years	2
	0 -2 years		1	
	Surveyor (Max 8 marks)	Qualification	Diploma in Survey (Minimum)	5
			Certificate in Survey	2
		Experience	> 6 Years	3
			3 – 5 Years	2
			0-3Years	1
	Foreman (Max 8marks)	Qualification	Diploma in Civil Engineering (Minimum)	5
			Certificate in Civil Engineering	2
		Experience	> 6 Years	3
3 – 5 Years			2	
0-3Years			1	
2	PLANT AND EQUIPMENT		Max 15	
	Single Drum Roller self-propelled - 1No.	Owned	3	

		Leased	2
Motor Grader		Owned	3
		Leased	2
Hydraulic excavator CAT 180HP or equivalent – 1No.		Owned	3
		Leased	2
Tipper Trucks 15 ton gross capacity – 3No.		Owned	6
		Leased	4.5
FINANCIAL CAPABILITY			Max 15
3	Financial statements	The financial accounts, balance sheets, profit and loss statements are certified by reputable audit firm. Contact information of the firm to be provided (Last three Years)	6
		Auditor’s practicing Membership Number by ICPAK indicated and valid practicing license attached.	2
		The Bank statements are from a reputable Bank. Contact information to be availed (Last Six Months)	1
		Computations for the following financial ratios from the latest audited accounts: <ul style="list-style-type: none"> • Working capital Ratio • Debt to Equity Ratio • Current Ratio • Operating cash flow Ratio 	2
Financial Information / Current work		Provide average turn-over figures for the last three (3) years showing current work commitment.	1
		Provide undertaking from the bank providing current line of credit specific to the tender	1
	On going works		2

4	WORK METHODOLOGY		Max 20
		Signed work programme chart and cash flow estimate	0-10
		Detailed method statement on how to carry out the intended works	0-10
5	WORK SAFETY MANAGEMENT		Max 10
	Proposals on traffic control, workers' safety & accident prevention		10
7	EXPERIENCE		Max 5
	General Experience (Attach Letters of Award and Completion Certificates for each project for the last 3 years)		3
	Two (2 No) of projects submitted above, should have a minimum Contract value of Kshs. 5,000,000 and similar in nature with this tender		2
	TOTAL		MAX 100

PART 1 – TENDERING PROCEDURES

SECTION I - INSTRUCTIONS TO TENDERERS

A. GENERAL PROVISIONS

1.0 Scope of Tender

The Procuring Entity as defined in the Appendix to Conditions of Contract invites tenders for Works Contract as described in the tender documents. The name, identification, and number of lots (contracts) of this Tender Document are **specified in the TDS**.

2.0 Fraud and Corruption

- 2.1 The Procuring Entity requires compliance with the provisions of the Public Procurement and Asset Disposal Act, 2015, Section 62 “Declaration not to engage in corruption”. The tender submitted by a person shall include a declaration that the person shall not engage in any corrupt or fraudulent practice and a declaration that the person or his or her sub-contractors are not debarred from participating in public procurement proceedings.
- 2.2 The Procuring Entity requires compliance with the provisions of the Competition Act 2010, regarding collusive practices in contracting. Any tenderer found to have engaged in collusive conduct shall be disqualified and criminal and/or civil sanctions may be imposed. To this effect, Tenders shall be required to complete and sign the “Certificate of Independent Tender Determination” annexed to the Form of Tender.
- 2.3 Tenderers shall permit and shall cause their agents (where declared or not), subcontractors, sub consultants, service providers, suppliers, and their personnel, to permit the Procuring Entity to inspect all accounts, records and other documents relating to any initial selection process, pre-qualification process, tender submission, proposal submission, and contract performance (in the case of award), and to have them audited by auditors appointed by the Procuring Entity.
- 2.4 Unfair Competitive Advantage -Fairness and transparency in the tender process require that the firms or their Affiliates competing for a specific assignment do not derive a competitive advantage from having provided consulting services related to this tender. To that end, the Procuring Entity shall indicate in the **Data Sheet** and make available to all the firms together with this tender document all information that would in that respect give such firm any unfair competitive advantage over competing firms.

3.0 Eligible Tenderers

- 3.1 A Tenderer may be a firm that is a private entity, a state-owned enterprise or institution subject to ITT 3.8, or an individual or any combination of such entities in the form of a joint venture (JV) under an existing agreement or with the intent to enter into such an agreement supported by a letter of intent. In the case of a joint venture, all members shall be jointly and severally liable for the execution of the entire Contract in accordance with

- the Contract terms. The JV shall nominate a Representative who shall have the authority to conduct all business for and on behalf of any and all the members of the JV during the tendering process and, in the event the JV is awarded the Contract, during contract execution. Members of a joint venture may not also make an individual tender, be a subcontractor in a separate tender or be part of another joint venture for the purposes of the same Tender. The maximum number of JV members shall be specified in the **TDS**.
- 3.2 Public Officers of the Procuring Entity, their Spouses, Child, Parent, Brothers or Sister. Child, Parent, Brother or Sister of a Spouse, their business associates or agents and firms/organizations in which they have a substantial or controlling interest shall not be eligible to tender or be awarded a contract. Public Officers are also not allowed to participate in any procurement proceedings.
- 3.3 A Tenderer shall not have a conflict of interest. Any tenderer found to have a conflict of interest shall be disqualified. A tenderer may be considered to have a conflict of interest for the purpose of this tendering process, if the tenderer:
- a) Directly or indirectly controls, is controlled by or is under common control with another tenderer; or
 - b) Receives or has received any direct or indirect subsidy from another tenderer; or Has the same legal representative as another tenderer; or
 - c) Has a relationship with another tenderer, directly or through common third parties, that puts it in a position to influence the tender of another tenderer, or
 - d) influence the decisions of the Procuring Entity regarding this tendering process; or
 - e) Any of its affiliates participated as a consultant in the preparation of the design or technical specifications of the goods or works that are the subject of the tender; or
 - f) any of its affiliates has been hired (or is proposed to be hired) by the Procuring Entity as a consultant for Contract implementation; or
 - g) Would be providing goods, works, or non-consulting services resulting from or directly related to consulting services for the preparation or implementation of the contract specified in this Tender Document; or
 - h) Has a close business or personal relationship with senior management or professional staff of the Procuring Entity who has the ability to influence the bidding process and:
 - (i) are directly or indirectly involved in the preparation of the Tender document or specifications of the Contract, and/or the Tender evaluation process of such contract; or

- (ii) may be involved in the implementation or supervision of such Contract unless the conflict stemming from such relationship has been resolved in a manner acceptable to the Procuring Entity throughout the tendering process and execution of the Contract.
- 3.4 A tenderer shall not be involved in corrupt, coercive, obstructive or fraudulent practice. A tenderer that is proven to have been involved in any of these practices shall be automatically disqualified.
- 3.5 A Tenderer (either individually or as a JV member) shall not participate in more than one Tender, except for permitted alternative tenders. This includes participation as a subcontractor in other Tenders. Such participation shall result in the disqualification of all Tenders in which the firm is involved. Members of a joint venture may not also make an individual tender, be a subcontractor in a separate tender or be part of another joint venture for the purposes of the same Tender. A firm that is not a tenderer or a JV member may participate as a subcontractor in more than one tender.
- 3.6 A Tenderer may have the nationality of any country, subject to the restrictions pursuant to ITT3.9. A Tenderer shall be deemed to have the nationality of a country if the Tenderer is constituted, incorporated or registered in and operates in conformity with the provisions of the laws of that country, as evidenced by its articles of incorporation (or equivalent documents of constitution or association) and its registration documents, as the case may be. This criterion also shall apply to the determination of the nationality of proposed subcontractors or sub-consultants for any part of the Contract including related Services.
- 3.7 A Tenderer that has been debarred from participating in public procurement shall be ineligible to tender or be awarded a contract. The list of debarred firms and individuals is available from the website of PPRA www.ppra.go.ke.
- 3.8 A Tenderer that is a state-owned enterprise or a public institution in Kenya may be eligible to tender and be awarded a Contract(s) only if it is determined by the Procuring Entity to meet the following conditions, i.e. if it is:
- i. A legal public entity of Government and/or public administration,
 - ii. financially autonomous and not receiving any significant subsidies or budget support from any public entity or Government, and
 - iii. operating under commercial law and vested with legal rights and liabilities similar to any commercial enterprise to enable it compete with firms in the private sector on an equal basis.

- 3.9 Firms and individuals shall be ineligible if their countries of origin are:
- (i) as a matter of law or official regulations, Kenya prohibits commercial relations with that country, or
 - (ii) by an act of compliance with a decision of the United Nations Security Council taken under Chapter VII of the Charter of the United Nations, Kenya prohibits any import of goods or contracting of works or services from that country, or any payments to any country, person, or entity in that country.

A tenderer shall provide such documentary evidence of eligibility satisfactory to the Procuring Entity, as the Procuring Entity shall reasonably request.

- 3.10 Foreign tenderers are required to source at least forty (40%) percent of their contract inputs (in supplies, local subcontracts and labor) from citizen suppliers and contractors. To this end, a foreign tenderer shall provide in its tender documentary evidence that this requirement is met. Foreign tenderers not meeting this criterion will be automatically disqualified. Information required to enable the Procuring Entity determine if this condition is met shall be provided for this purpose in “*SECTION III-EVALUATION AND QUALIFICATION CRITERIA, Item 9*”.
- 3.11 Pursuant to the eligibility requirements of ITT4.10, a tender is considered a foreign tenderer, if the tenderer is not registered in Kenya or if the tenderer is registered in Kenya and has less than 51 percent ownership by Kenyan citizens. JVs are considered as foreign tenderers if the individual member firms are not registered in Kenya or if are registered in Kenya and have less than 51 percent ownership by Kenyan citizens. The JV shall not subcontract to foreign firms more than 10 percent of the contract price, excluding provisional sums.
- 3.12 The National Construction Authority Act of Kenya requires that all local and foreign contractors be registered with the National Construction Authority and be issued with a Registration Certificate before they can undertake any construction works in Kenya. Registration shall not be a condition for tender, but it shall be a condition of contract award and signature. A selected tenderer shall be given opportunity to register before such award and signature of contract. Application for registration with National Construction Authority may be accessed from the website www.nca.go.ke.
- 3.13 The Competition Act of Kenya requires that firms wishing to tender as Joint Venture undertakings which may prevent, distort or lessen competition in provision of services are prohibited unless they are exempt in accordance with the provisions of Section 25 of the Competition Act, 2010. JVs will be required to seek for exemption from the Competition Authority. Exemption shall not be a condition for tender, but it shall be a condition of contract award and signature. A JV tenderer shall be given opportunity to

seek such exemption as a condition of award and signature of contract. Application for exemption from the Competition Authority of Kenya may be accessed from the website www.cak.go.ke.

- 3.14 A Kenyan tenderer shall be eligible to tender if it provides evidence of having fulfilled his/her tax obligations by producing a valid tax compliance or valid tax certificate issued by the Kenya Revenue Authority.

4.0 Eligible Goods, Equipment, and Services

- 4.1 Goods, equipment and services to be supplied under the Contract may have their origin in any country that is not ineligible under ITT3.9. At the Procuring Entity's request, Tenderers may be required to provide evidence of the origin of Goods, equipment and services.
- 4.2 Any goods, works and production processes with characteristics that have been declared by the relevant national environmental protection agency or by other competent authority as harmful to human beings and to the environment shall not be eligible for procurement.

5.0 Tenderer's Responsibilities

- 5.1 The tenderer shall bear all costs associated with the preparation and submission of his/her tender, and the Procuring Entity will in no case be responsible or liable for those costs.
- 5.2 The tenderer, at the tenderer's own responsibility and risk, is encouraged to visit and examine and inspect the Site of the Works and its surroundings and obtain all information that may be necessary for preparing the tender and entering into a contract for construction of the Works. The costs of visiting the Site shall be at the tenderer's own expense.
- 5.3 The Tenderer and any of its personnel or agents will be granted permission by the Procuring Entity to enter up on its premises and lands for the purpose of such visit. The Tenderer shall indemnify the Procuring Entity against all liability arising from death or personal injury, loss of or damage to property, and any other losses and expenses incurred as a result of the examination and inspection.
- 5.4 The tenderer shall provide in the Form of Tender and Qualification Information, a preliminary description of the proposed work method and schedule, including charts, as necessary or required.

B. CONTENTS OF TENDER DOCUMENTS**6.0 Sections of Tender Document**

- 6.1 The tender document consists of Parts 1, 2, and 3, which includes all the sections specified below, and which should be read in conjunction with any Addenda issued in accordance with ITT10.

PART 1: Tendering Procedures

Section I: Instructions to Tenderers

Section II: Tender Data Sheet (TDS)

Section III: Evaluation and Qualification Criteria

Section IV: Tendering Forms

PART 2: Works' Requirements

Section V: Bills of Quantities

Section VI: Specifications Section

VII: Drawings

PART3: Conditions of Contract and Contract Forms

Section VIII: General Conditions (GCC)

Section IX: Particular Conditions of Contract

Section X: Contract Forms

- 6.2 The Invitation to Tender Notice issued by the Procuring Entity is not part of the Contract documents.
- 6.3 Unless obtained directly from the Procuring Entity, the Procuring Entity is not responsible for the completeness of the Tender document, responses to requests for clarification, the minutes of a pre-arranged site visit and those of the pre-Tender meeting (if any), or Addenda to the Tender document in accordance with ITT 10. In case of any contradiction, documents obtained directly from the Procuring Entity shall prevail.
- 6.4 The Tenderer is expected to examine all instructions, forms, terms, and specifications in the Tender Document and to furnish with its Tender all information and documentation as is required by the Tender document.

7.0 Site Visit

- 7.1 The Tenderer, at the Tenderer's own responsibility and risk, is encouraged to visit and examine and inspect the site(s) of the required contracts and obtain all information that

may be necessary for preparing a tender. The costs of visiting the Site shall be at the Tenderer's own expense. The Procuring Entity shall specify in the **TDS** if a pre-arranged Site visit and or a pre-tender meeting will be held, when and where. The Tenderer's designated representative is invited to attend a pre-arranged site visit and a pre-tender meeting, as the case may be.

8.0 Pre bid Meeting

- 8.1 The Procuring Entity shall specify in the TDS if a pre-tender meeting will be held, when and where. The Procuring Entity shall also specify in the TDS if a pre-arranged pretender site visit will be held and when. The Tenderer's designated representative is invited to attend a pre-arranged pretender visit of the site of the works. The purpose of the meeting will be to clarify issues and to answer questions on any matter that may be raised at that stage.
- 8.2 The Tenderer is requested to submit any questions in writing, to reach the Procuring Entity not later than the period specified in the **TDS** before the meeting.
- 8.3 Minutes of a pre-arranged site visit and those of the pre-tender meeting, if applicable, including the text of the questions asked by Tenderers and the responses given, together with any responses prepared after the meeting, will be transmitted promptly to all Tenderers who have acquired the Tender Documents. Minutes shall not identify the source of the questions asked.
- 8.4 The Procuring Entity shall also promptly publish anonymized (*no names*) Minutes of the pre-arranged site visit and those of the pre-tender meeting at the web page identified **in the TDS**. Any modification to the Tender Documents that may become necessary as a result of the pre-arranged site visit and those of the pre-tender meeting shall be made by the Procuring Entity exclusively through the issue of an Addendum pursuant to ITT 8 and not through the minutes of the pre-Tender meeting. Non-attendance at the pre-arranged site visit and the pre-tender meeting will not be a cause for disqualification of a Tenderer.

9.0 Clarifications

- 9.1 A Tenderer requiring any clarification of the Tender Document shall contact the Procuring Entity in writing at the Procuring Entity's address specified in the TDS or raise its enquiries during the pre-Tender meeting and the pre-arranged pretender visit of the site of the works if provided for in accordance with ITT 8.4. The Procuring Entity will respond in writing to any request for clarification, provided that such request is received no later than the period specified in the TDS prior to the deadline for submission of tenders. The Procuring Entity shall forward copies of its response to all tenderers who have acquired the Tender Documents in accordance with ITT 6.3, including a description of the inquiry but without identifying its source. If specified in the TDS, the Procuring Entity shall also promptly publish its response at the web page identified in the TDS. Should the clarification result in changes to the essential elements of the

Tender Documents, the Procuring Entity shall amend the Tender Documents appropriately following the procedure under ITT 8.4.

10.0 Amendment of Tender Documents

- 10.1 At any time prior to the deadline for submission of Tenders, the Procuring Entity may amend the Tender Documents by issuing addenda.
- 10.2 Any addendum issued shall be part of the Tender Documents and shall be communicated in writing to all who have obtained the Tender Documents from the Procuring Entity. The Procuring Entity shall also promptly publish the addendum on the Procuring Entity's website in accordance with ITT 7.5.
- 10.3 To give Tenderers reasonable time in which to take an addendum into account in preparing their Tenders, the Procuring Entity should extend the deadline for the submission of Tenders, pursuant to ITT 22.2.

C. PREPARATION OF TENDERS

11.0 Cost of Tendering

- 11.1 The Tenderer shall meet all costs associated with the preparation and submission of its Tender, and the Procuring Entity shall not be responsible or liable for those costs, regardless of the conduct or outcome of the tendering process.

12.0 Language of Tender

- 12.1 The Tender, as well as all correspondence and documents relating to the tender exchanged by the tenderer and the Procuring Entity, shall be written in the English Language. Supporting documents and printed literature that are part of the Tender may be in another language provided they are accompanied by an accurate and notarized translation of the relevant passages into the English Language, in which case, for purposes of interpretation of the Tender, such translation shall govern.

13.0 Documents Comprising the Tender

- 13.1 The Tender shall comprise the following:
 - i. Form of Tender prepared in accordance with ITT 12;
 - ii. Schedules including priced Bill of Quantities, completed in accordance with ITT 12 and ITT 14;
 - iii. Tender Security or Tender-Securing Declaration, in accordance with ITT 19.1;
 - iv. Alternative Tender, if permissible, in accordance with ITT 13;

- v. Authorization: written confirmation authorizing the signatory of the Tender to commit the Tenderer, in accordance with ITT 20.3;
- vi. Qualifications: documentary evidence in accordance with ITT 17 establishing the Tenderer's qualifications to perform the Contract if its Tender is accepted;
- vii. Conformity: a technical proposal in accordance with ITT 16;
- viii. Any other document required in the TDS.

13.2 In addition to the requirements under ITT 11.1, Tenders submitted by a JV shall include a copy of the Joint Venture Agreement entered into by all members. Alternatively, a letter of intent to execute a Joint Venture Agreement in the event of a successful Tender shall be signed by all members and submitted with the Tender, together with a copy of the proposed JV Agreement. Change of membership and conditions of the JV prior to contract signature will render the tender liable for disqualification.

13.3 The Tenderer shall furnish in the Form of Tender information on commissions and gratuities, if any, paid or to be paid to agents or any other party relating to this Tender.

14.0 Form of Tender and Schedules

14.1 The Form of Tender and Schedules, including the Bill of Quantities, shall be prepared using the relevant forms furnished in Section IV, Tendering Forms. The forms must be completed without any alterations to the text, and no substitutes shall be accepted except as provided under ITT 20.3. All blank spaces shall be filled in with the information requested. The Tenderer shall chronologically serialize all pages of the tender documents submitted.

15.0 Alternative Tenders

15.1 Unless otherwise specified in the TDS, alternative Tenders shall not be considered.

15.2 When alternative times for completion are explicitly invited, a statement to that effect will be included in the **TDS**, and the method of evaluating different alternative times for completion will be described in Section III, Evaluation and Qualification Criteria.

15.3 Except as provided under ITT13.4 below, Tenderers wishing to offer technical alternatives to the requirements of the Tender Documents must first price the Procuring Entity's design as described in the Tender Documents and shall further provide all information necessary for a complete evaluation of the alternative by the Procuring Entity, including drawings, design calculations, technical specifications, breakdown of prices, and proposed construction methodology and other relevant details. Only the technical alternatives, if any, of the Tenderer with the Winning Tender conforming to the basic technical requirements shall be considered by the Procuring Entity. When specified

in the **TDS**, Tenderers are permitted to submit alternative technical solutions for specified parts of the Works, and such parts will be identified in the **TDS**, as will the method for their evaluating, and described in Section VII, Works' Requirements.

16.0 Tender Prices and Discounts

- 16.1 The prices and discounts (including any price reduction) quoted by the Tenderer in the Form of Tender and in the Bill of Quantities shall conform to the requirements specified below.
- 16.2 The Tenderer shall fill in rates and prices for all items of the Works described in the Bill of Quantities. Items against which no rate or price is entered by the Tenderer shall be deemed covered by the rates for other items in the Bill of Quantities and will not be paid for separately by the Procuring Entity. An item not listed in the priced Bill of Quantities shall be assumed to be not included in the Tender, and provided that the Tender is determined substantially responsive notwithstanding this omission, the average price of the item quoted by substantially responsive Tenderers will be added to the Tender price and the equivalent total cost of the Tender so determined will be used for price comparison.
- 16.3 The price to be quoted in the Form of Tender, in accordance with ITT 12, shall be the total price of the Tender, including any discounts offered.
- 16.4 The Tenderer shall quote any discounts and the methodology for their application in the Form of Tender, in accordance with ITT 12
- 16.5 It will be specified in the **TDS** if the rates and prices quoted by the Tenderer are or are not subject to adjustment during the performance of the Contract in accordance with the provisions of the Conditions of Contract, except in cases where the contract is subject to fluctuations and adjustments, not fixed price. In such a case, the Tenderer shall furnish the indices and weightings for the price adjustment formulae in the Schedule of Adjustment Data and the Procuring Entity may require the Tenderer to justify its proposed indices and weightings.
- 16.6 Where tenders are being invited for individual lots (contracts) or for any combination of lots (packages), tenderers wishing to offer discounts for the award of more than one Contract shall specify in their Tender the price reductions applicable to each package, or alternatively, to individual Contracts within the package. Discounts shall be submitted in accordance with ITT 14.4, provided the Tenders for all lots (contracts) are opened at the same time.
- 16.7 All duties, taxes, and other levies payable by the Contractor under the Contract, or for any other cause, as of the date 30 days prior to the deadline for submission of Tenders, shall be included in the rates and prices and the total Tender Price submitted by the Tenderer.

17.0 Currencies of Tender and Payment

- 17.1 The currency (ies) of the Tender and the currency (ies) of payments shall be the same.
- 17.2 Tenderers shall quote entirely in Kenya Shillings. The unit rates and the prices shall be quoted by the Tenderer in the Bill of Quantities, entirely in Kenya shillings. A Tenderer expecting to incur expenditures in other currencies for inputs to the Works supplied from outside Kenya (referred to as “the foreign currency requirements”) shall device own ways of getting foreign currency to meet those expenditures.

18.0 Documents Comprising the Technical Proposal

- 18.1 The Tenderer shall furnish a technical proposal including a statement of work methods, equipment, personnel, schedule and any other information as stipulated in Section IV, Tender Forms, and insufficient detail to demonstrate the adequacy of the Tenderer's proposal to meet the work's requirements and the completion time.

19.0 Documents Establishing the Eligibility and Qualifications of the Tenderer

- 19.1 Tenderers shall complete the Form of Tender, included in Section IV, Tender Forms, to establish Tenderer's eligibility in accordance with ITT 4.
- 19.2 In accordance with Section III, Evaluation and Qualification Criteria, to establish its qualifications to perform the Contract the Tenderer shall provide the information requested in the corresponding information sheets included in Section IV, Tender Forms.
- 19.3 If a margin of preference applies as specified in accordance with ITT 33.1, national tenderers, individually or in joint ventures, applying for eligibility for national preference shall supply all information required to satisfy the criteria for eligibility specified in accordance with ITT 33.1.
- 19.4 Tenderers shall be asked to provide, as part of the data for qualification, such information, including details of ownership, as shall be required to determine whether, according to the classification established by the Procuring Entity, a particular contract or or group of contractors qualifies for a margin of preference. Further the information will enable the Procuring Entity identify any actual or potential conflict of interest in relation to the procurement and/or contract management processes, or possibility of collusion between tenderers, and there by help to prevent any corrupt influence in relation to the procurement process or contract management.
- 19.5 The purpose of the information described **in ITT 17.2** above overrides any claims to confidentiality which a tenderer may have. There can be no circumstances in which it would be justified for a tenderer to keep information relating to its ownership and control confidential where it is tendering to undertake public sector work and receive public sector funds. Thus, confidentiality will not be accepted by the Procuring Entity as a justification for a Tenderer's failure to disclose, or failure to provide required information on its ownership and control.

- 19.6 The Tenderer shall provide further documentary proof, information or authorizations that the Procuring Entity may request in relation to ownership and control which information on any changes to the information which was provided by the tenderer under ITT 6.4. The obligations to require this information shall continue for the duration of the procurement process and contract performance and after completion of the contract, if any change to the information previously provided may reveal a conflict of interest in relation to the award or management of the contract.
- 19.7 All information provided by the tenderer pursuant to these requirements must be complete, current and accurate as at the date of provision to the Procuring Entity. In submitting the information required pursuant to these requirements, the Tenderer shall warrant that the information submitted is complete, current and accurate as at the date of submission to the Procuring Entity.
- 19.8 If a tenderer fails to submit the information required by these requirements, its tenderer will be rejected. Similarly, if the Procuring Entity is unable, after taking reasonable steps, to verify to a reasonable degree the information submitted by a tenderer pursuant to these requirements, then the tender will be rejected.
- 19.9 If information submitted by a tenderer pursuant to these requirements, or obtained by the Procuring Entity (whether through its own enquiries, through notification by the public or otherwise), shows any conflict of interest which could materially and improperly benefit the tenderer in relation to the procurement or contract management process, then:
- i. If the procurement process is still on going, the tenderer will be disqualified from the procurement process,
 - ii. If the contract has been awarded to that tenderer, the contract award will be set aside, the tenderer will be referred to the relevant law enforcement authorities for investigation of whether the tenderer or any other persons have committed any criminal offence.
- 19.10 If a tenderer submits information pursuant to these requirements that is incomplete, inaccurate or out-of-date, or attempts to obstruct the verification process, then the consequences ITT 17.8 will ensue unless the tenderer can show to the reasonable satisfaction of the Procuring Entity that any such act was not material, or was due to genuine error which was not attributable to the intentional act, negligence or recklessness of the tenderer.

20.0 Period of Validity of Tenders

- 20.1 Tenders shall remain valid for the Tender Validity period specified in the **TDS**. The Tender Validity period starts from the date fixed for the Tender submission deadline (as

- prescribed by the Procuring Entity in accordance with ITT 22). A Tender valid for a shorter period shall be rejected by the Procuring Entity as non-responsive.
- 20.2 In exceptional circumstances, prior to the expiration of the Tender validity period, the Procuring Entity may request Tenderers to extend the period of validity of their Tenders. The request and the responses shall be made in writing. If a Tender Security is requested in accordance with ITT 19, it shall also be extended for thirty (30) days beyond the deadline of the extended validity period. A Tenderer may refuse the request without forfeiting its Tender security. A Tenderer granting their quest shall not be required or permitted to modify its Tender.
- 20.3 If the award is delayed by a period exceeding the number of days to be specified in the TDS days beyond the expiry of the initial tender validity period, the Contract price shall be determined as follows:
- a) in the case of **fixed** price contracts, the Contract price shall be the tender price adjusted by the factor specified in the TDS;
 - b) In the case of adjustable price contracts, no adjustment shall be made; or in any case, tender evaluation shall be based on the tender price without taking into consideration the applicable correction from those indicated above.

21.0 Tender Security

- 21.1 The Tenderer shall furnish as part of its Tender, either a Tender-Securing Declaration or a Tender Security as specified in the **TDS**, in original form and, in the case of a Tender Security, in the amount and currency **specified in the TDS**. A Tender-Securing Declaration shall use the form included in Section IV, Tender Forms.
- 21.2 If a Tender Security is specified pursuant to ITT19.1, the Tender Security shall be a demand guarantee in any of the following forms at the Tenderer's option:
- i. cash;
 - ii. a bank guarantee;
 - iii. a guarantee by an insurance company registered and licensed by the Insurance Regulatory Authority listed by the Authority; or
 - iv. a guarantee issued by a financial institution approved and licensed by the Central Bank of Kenya, from a reputable source, and an eligible country.
- 21.3 If an unconditional bank guarantee is issued by a bank located outside Kenya, the issuing bank shall have a correspondent bank located in Kenya to make it enforceable. The

- Tender Security shall be valid for thirty (30) days beyond the original validity period of the Tender, or beyond any period of extension if requested under ITT 18.2.
- 21.4 If a Tender Security or Tender-Securing Declaration is specified pursuant to ITT 19.1, any Tender not accompanied by a substantially responsive Tender Security or Tender-Securing Declaration shall be rejected by the Procuring Entity as non-responsive.
- 21.5 If a Tender Security is specified pursuant to ITT 19.1, the Tender Security of unsuccessful Tenderers shall be returned as promptly as possible upon the successful Tenderer's signing the Contract and furnishing the Performance Security and any other documents required in the TDS. The Procuring Entity shall also promptly return the tender security to the tenderers where the procurement proceedings are terminated, all tenders were determined non-responsive or a bidder declines to extend tender validity period.
- 21.6 The Tender Security of the successful Tenderer shall be returned as promptly as possible once the successful Tenderer has signed the Contract and furnished the required Performance Security, and any other documents required in the TDS.
- 21.7 The Tender Security may be forfeited or the Tender-Securing Declaration executed:
- a) if a Tenderer withdraws its Tender during the period of Tender validity specified by the Tenderer on the Form of Tender, or any extension there to provide by the Tenderer; or
 - b) if the successful Tenderer fails to:
 - i. sign the Contract in accordance with ITT 47; or
 - ii. furnish a Performance Security and if required in the TDS, and any other documents required in the TDS.
- 21.8 Where tender securing declaration is executed, the Procuring Entity shall recommend to the PPRA that PPRA debars the Tenderer from participating in public procurement as provided in the law.
- 21.9 The Tender Security or the Tender-Securing Declaration of a JV shall be in the name of the JV that submits the Tender. If the JV has not been legally constituted into a legally enforceable JV at the time of tendering, the Tender Security or the Tender-Securing Declaration shall be in the names of all future members as named in the letter of intent referred to in ITT 4.1 and ITT 11.2.
- 21.10 A tenderer shall not issue a tender security to guarantee itself.

22.0 Format and Signing of Tender

- 22.1 The Tenderer shall prepare one original of the documents comprising the Tender as described in ITT 11 and clearly mark it “ORIGINAL.” Alternative Tenders, if permitted in accordance with ITT 13, shall be clearly marked “ALTERNATIVE.” In addition, the Tenderer shall submit copies of the Tender, in the number **specified in the TDS** and clearly mark them “COPY.” In the event of any discrepancy between the original and the copies, the original shall prevail.
- 22.2 Tenderers shall mark as “CONFIDENTIAL” all information in their Tenders which is confidential to their business. This may include proprietary information, trade secrets, or commercial or financially sensitive information.
- 22.3 The original and all copies of the Tender shall be typed or written in indelible ink and shall be signed by a person duly authorized to sign on behalf of the Tenderer. This authorization shall consist of a written confirmation as specified in the **TDS** and shall be attached to the Tender. The name and position held by each person signing the authorization must be typed or printed below the signature. All pages of the Tender where entries or amendments have been made shall be signed or initialed by the person signing the Tender.
- 22.4 In case the Tenderer is a JV, the Tender shall be signed by an authorized representative of the JV on behalf of the JV, and so as to be legally binding on all the members as evidenced by a power of attorney signed by their legally authorized representatives.
- 22.5 Any inter-lineation, erasures, or overwriting shall be valid only if they are signed or initialed by the person signing the Tender.

D. SUBMISSION AND OPENING OF TENDERS**23.0 Sealing and Marking of Tenders**

- 23.1 The Tenderer shall deliver the Tender in a single sealed envelope, or in a single sealed package, or in a single sealed container bearing the name and Reference number of the Tender, addressed to the Procuring Entity and a warning not to open before the time and date for Tender opening date. Within the single envelope, package or container, the Tenderer shall place the following separate, sealed envelopes:
- i. in an envelope or package or container marked “ORIGINAL”, all documents comprising the Tender, as described in ITT 11; and
 - ii. in an envelope or package or container marked “COPIES” all required copies of the Tender; and
 - iii. if alternative Tenders are permitted in accordance with ITT 13, and if relevant:
 - a) in an envelope or package or container marked “ORIGINAL - ALTERNATIVE TENDER”, the alternative Tender; and
 - b) in the envelope or package or container marked “COPIES-

ALTERNATIVETENDER”, all required copies of the alternative Tender.

The inner envelopes or packages or containers shall:

- a) bear the name and address of the Procuring Entity.
- b) Bear the name and address of the Tenderer; and
- c) Bear the name and Reference number of the Tender.

23.2 If an envelope or package or container is not sealed and marked as required, the *Procuring Entity* will assume no responsibility for the misplacement or premature opening of the Tender. Tenders that were misplaced or opened prematurely will not be accepted.

24.0 Deadline for Submission of Tenders

24.1 Tenders must be received by the Procuring Entity at the address specified in the **TDS** and no later than the date and time also specified in the **TDS**. When so specified in the **TDS**, Tenderers shall have the option of submitting their Tenders electronically. Tenderers submitting Tenders electronically shall follow the electronic Tender submission procedures specified in the **TDS**.

24.2 The Procuring Entity may, at its discretion, extend the deadline for the submission of Tenders by amending the Tender Documents in accordance with ITT 8, in which case all rights and obligations of the Procuring Entity and Tenderers previously subject to the deadline shall thereafter be subject to the deadline as extended.

25.0 Late Tenders

25.1 The Procuring Entity shall not consider any Tender that arrives after the deadline for submission of tenders, in accordance with ITT 22. Any Tender received by the Procuring Entity after the deadline for submission of Tenders shall be declared late, rejected, and returned unopened to the Tenderer.

26.0 Withdrawal, Substitution, and Modification of Tenders

26.1 A Tenderer may withdraw, substitute, or modify its Tender after it has been submitted by sending a written notice, duly signed by an authorized representative, and shall include a copy of the authorization in accordance with ITT 20.3, (except that withdrawal notices do not require copies). The corresponding substitution or modification of the Tender must accompany the respective written notice. All notices must be:

- a) prepared and submitted in accordance with ITT 20 and ITT 21 (except that

withdrawals notices do not require copies), and in addition, the respective envelopes shall be clearly marked “WITHDRAWAL,” “SUBSTITUTION,” “MODIFICATION; “and

- b) received by the Procuring Entity prior to the deadline prescribed for submission of Tenders, in accordance with ITT 22.
- 26.2 Tenders requested to be withdrawn in accordance with ITT 24.1 shall be returned unopened to the Tenderers.
- 26.3 No Tender may be withdrawn, substituted, or modified in the interval between the deadline for submission of Tenders and the expiration of the period of Tender validity specified by the Tenderer on the Form of Tender or any extension thereof.

27.0 Tender Opening

- 27.1 Except in the cases specified in ITT 23 and ITT 24.2, the Procuring Entity shall publicly open and read out all Tenders received by the deadline, at the date, time and place specified **in the TDS**, in the presence of Tenderers' designated representatives and anyone who chooses to attend. Any specific electronic Tender opening procedures required if electronic Tendering is permitted in accordance with ITT 22.1, shall be as specified in the **TDS**.
- 27.2 First, envelopes marked “WITHDRAWAL” shall be opened and read out and the envelopes with the corresponding Tender shall not be opened but returned to the Tenderer. No Tender withdrawal shall be permitted unless the corresponding withdrawal notice contains a valid authorization to request the withdrawal and is read out at tender opening.
- 27.3 Next, envelopes marked “SUBSTITUTION” shall be opened and read out and exchanged with the corresponding Tender being substituted, and the substituted Tender shall not be opened, but returned to the Tenderer. No Tender substitution shall be permitted unless the corresponding substitution notice contains a valid authorization to request the substitution and is read out at Tender opening.
- 27.4 Next, envelopes marked “MODIFICATION” shall be opened and read out with the corresponding Tender. No Tender modification shall be permitted unless the corresponding modification notice contains a valid authorization to request the modification and is read out at Tender opening.
- 27.5 Next, all remaining envelopes shall be opened on eata time, reading out: the name of the Tenderer and whether there is a modification; the total Tender Price, per lot (contract) if applicable, including any discounts and alternative Tenders; the presence or absence of a Tender Security or Tender-Securing Declaration, if required; and any other details as the Procuring Entity may consider appropriate.
- 27.6 Only Tenders, alternative Tenders and discounts that are opened and read out at Tender opening shall be considered further for evaluation. The Form of Tender and pages of the

- Bill of Quantities (to be decided on by the tender opening committee) are to be initialed by the members of the tender opening committee attending the opening.
- 27.7 At the Tender Opening, the Procuring Entity shall neither discuss the merits of any Tender nor reject any Tender (except for late Tenders, in accordance with ITT 23.1).
- 27.8 The Procuring Entity shall prepare minutes of the Tender Opening that shall include, as a minimum:
- a) The name of the Tenderer and whether there is a withdrawal, substitution, or modification;
 - b) The Tender Price, per lot (contract) if applicable, including any discounts;
 - c) any alternative Tenders;
 - d) the presence or absence of a Tender Security, if one was required.
 - e) number of pages of each tender document submitted.
- 27.9 The Tenderers' representatives who are present shall be requested to sign the minutes. The omission of a Tenderer's signature on the minutes shall not invalidate the contents and effect of the minutes. A copy of tender opening register shall be issued to a tenderer upon request.

E. Evaluation and Comparison of Tenders

28.0 Confidentiality

- 28.1 Information relating to the evaluation of Tenders and recommendation of contract award shall not be disclosed to Tenderers or any other persons not officially concerned with the Tender process until information on Intention to Award the Contract is transmitted to all Tenderers in accordance with ITT 43.
- 28.2 Any effort by a Tenderer to influence the Procuring Entity in the evaluation of the Tenders or Contract award decisions may result in the rejection of its tender.
- 28.3 Notwithstanding ITT 26.2, from the time of tender opening to the time of contract award, if a tenderer wishes to contact the Procuring Entity on any matter related to the tendering process, it shall do so in writing.

29.0 Clarification of Tenders

- 29.1 To assist in the examination, evaluation, and comparison of the tenders, and qualification of the tenderers, the Procuring Entity may, at its discretion, ask any tenderer for a clarification of its tender, given a reasonable time for a response. Any clarification submitted by a tenderer that is not in response to a request by the Procuring Entity shall not be considered. The Procuring Entity's request for clarification and the response shall be in writing. No change, including any voluntary increase or decrease, in the prices or substance of the tender shall be sought, offered, or permitted, except to confirm the

correction of arithmetic errors discovered by the Procuring Entity in the evaluation of the tenders, in accordance with ITT 31.

- 29.2 If a tenderer does not provide clarifications of its tender by the date and time set in the Procuring Entity's request for clarification, its Tender may be rejected.

30.0 Deviations, Reservations, and Omissions

30.1 During the evaluation of tenders, the following definitions apply:

- i. "Deviation" is a departure from the requirements specified in the tender document;
- ii. "Reservation" is the setting of limiting conditions or withholding from complete acceptance of the requirements specified in the tender document; and
- iii. "Omission" is the failure to submit part or all of the information or documentation required in the Tender document.

31.0 Determination of Responsiveness

31.1 The Procuring Entity's determination of a Tender's responsiveness is to be based on the contents of the tender itself, as defined in ITT 11.

31.2 A substantially responsive Tender is one that meets the requirements of the Tender document without material deviation, reservation, or omission. A material deviation, reservation, or omission is one that, if accepted, would:

- (i) Affect in any substantial way the scope, quality, or performance of the Works specified in the Contract; or
- (ii) limit in any substantial way, inconsistent with the tender document, the Procuring Entity's rights or the tenderer's obligations under the proposed contract; or
- (iii) if rectified, would unfairly affect the competitive position of other tenderers presenting substantially responsive tenders.

31.3 The Procuring Entity shall examine the technical aspects of the tender submitted in accordance with ITT 16, to confirm that all requirements of Section VII, Works' Requirements have been met without any material deviation, reservation or omission.

31.4 If a tender is not substantially responsive to the requirements of the tender document, it shall be rejected by the Procuring Entity and may not subsequently be made responsive by correction of the material deviation, reservation, or omission.

32.0 Non-material Non-conformities

32.1 Provided that a tender is substantially responsive, the Procuring Entity may waive any non-conformities in the tender.

32.2 Provided that a Tender is substantially responsive, the Procuring Entity may request that the tenderer submit the necessary information or documentation, within a reasonable period of time, to rectify nonmaterial non- conformities in the tender related to

documentation requirements. Requesting information or documentation on such non-conformities shall not be related to any aspect of the price of the tender. Failure of the tenderer to comply with the request may result in the rejection of its tender.

- 32.3 Provided that a tender is substantially responsive, the Procuring Entity shall rectify quantifiable nonmaterial non-conformities related to the Tender Price. To this effect, the Tender Price shall be adjusted, for comparison purposes only, to reflect the price of a missing or non-conforming item or component in the manner specified **in the TDS**.

33.0 Arithmetical Errors

- 33.1 The tender sum as submitted and read out during the tender opening shall be absolute and final and shall not be the subject of correction, adjustment or amendment in anyway by any person or entity.
- 33.2 Provided that the Tender is substantially responsive, the Procuring Entity shall handle errors on the following basis:
- i. Any error detected if considered a major deviation that affects the substance of the tender, shall lead to disqualification of the tender as non-responsive.
 - ii. Any errors in the submitted tender arising from a miscalculation of unit price, quantity, sub total and total bid price shall be considered as a major deviation that affects the substance of the tender and shall lead to disqualification of the tender as non-responsive. and
 - iii. If there is a discrepancy between words and figures, the amount in words shall prevail
- 33.3 Tenderers shall be notified of any error detected in their bid during the notification of award.

34.0 Currency Provisions

- 34.1 Tenders will priced be in Kenya Shillings only. Tenderers quoting in currencies other thanin Kenya shillings will be determined non-responsive and rejected.

35.0 Margin of Preference and Reservations

- 35.1 No margin of preference shall be allowed on contracts for small works.
- 35.2 Where it is intended to reserve the contract to specific groups under Small and MediumEnterprises, or enterprise of women, youth and/or persons living with disability, who are appropriately registered as such by the authority to be specified in the TDS, a procuring entity shall ensure that the invitation to tender specifically indicates that only businesses/firms belonging to those specified groups are the only ones eligible to tender. Otherwise if no so stated, the invitation will be open to all tenderers.

36.0 Nominated Subcontractors

- 36.1 Unless otherwise stated **in the TDS**, the Procuring Entity does not intend to execute any specific elements of the Works by subcontractors selected/nominated by the Procuring Entity. In case the Procuring Entity nominates a subcontractor, the subcontract agreement shall be signed by the Subcontractor and the Procuring Entity. The main contract shall specify the working arrangements between the main contractor and the nominated subcontractor.
- 36.2 Tenderers may propose subcontracting up to the percentage of total value of contracts or the volume of works as specified **in the TDS**. Subcontractors proposed by the Tenderer shall be fully qualified for their parts of the Works.
- 36.3 The subcontractor's qualifications shall not be used by the Tenderer to qualify for the Works unless their specialized parts of the Works were previously designated so by the Procuring Entity **in the TDS** as can be met by subcontractors referred to hereafter as 'Specialized Subcontractors', in which case, the qualifications of the Specialized Subcontractors proposed by the Tenderer may be added to the qualifications of the Tenderer.

37.0 Evaluation of Tenders

- 37.1 The Procuring Entity shall use the criteria and methodologies listed in this ITT and Section III, Evaluation and Qualification Criteria. No other evaluation criteria or methodologies shall be permitted. By applying the criteria and methodologies the Procuring Entity shall determine the Lowest Evaluated Tender in accordance with ITT 40.
- 37.2 To evaluate a Tender, the Procuring Entity shall consider the following:
- i. Price adjustment in accordance with ITT 31.1(iii); excluding provisional sums and contingencies, if any, but including Day work items, where priced competitively;
 - ii. Price adjustment due to discounts offered in accordance with ITT 14.4;
 - iii. converting the amount resulting from applying (a) and (b) above, if relevant, to a single currency in accordance with ITT 32;
 - iv. price adjustment due to quantifiable non material non-conformities in accordance with ITT 30.3; and
 - v. any additional evaluation factors specified **in the TDS** and Section III, Evaluation and Qualification Criteria.
- 37.3 The estimated effect of the price adjustment provisions of the Conditions of Contract, applied over the period of execution of the Contract, shall not be considered intender evaluation.

37.4 In the case of multiple contracts or lots, Tenderers shall be allowed to tender for one or more lots and the methodology to determine the lowest evaluated cost of the lot (contract) combinations, including any discounts offered in the Form of Tender, is specified in Section III, Evaluation and Qualification Criteria.

38.0 Comparison of Tenders

The Procuring Entity shall compare the evaluated costs of all substantially responsive Tenders established in accordance with ITT 35.2 to determine the Tender that has the lowest evaluated cost.

39.0 Abnormally Low Tenders

39.1 An Abnormally Low Tender is one where the Tender price, in combination with other elements of the Tender, appears so low that it raises material concerns as to the capability of the Tenderer in regards to the Tenderer's ability to perform the Contract for the offered Tender Price or that genuine competition between Tenderers is compromised.

39.2 In the event of identification of a potentially Abnormally Low Tender, the Procuring Entity shall seek written clarifications from the Tenderer, including detailed price analyses of its Tender price in relation to the subject matter of the contract, scope, proposed methodology, schedule, allocation of risks and responsibilities and any other requirements of the Tender document.

39.3 After evaluation of the price analyses, in the event that the Procuring Entity determines that the Tenderer has failed to demonstrate its capability to perform the Contract for the offered Tender Price, the Procuring Entity shall reject the Tender.

40.0 Abnormally High Tenders

40.1 An abnormally high tender price is one where the tender price, in combination with other constituent elements of the Tender, appears unreasonably too high to the extent that the Procuring Entity is concerned that it (the Procuring Entity) may not be getting value for money or it may be paying too high a price for the contract compared with market prices or that genuine competition between Tenderers is compromised.

40.2 In case of an abnormally high price, the Procuring Entity shall make a survey of the market prices, check if the estimated cost of the contract is correct and review the Tender Documents to check if the specifications, scope of work and conditions of contract are contributory to the abnormally high tenders. The Procuring Entity may also seek written clarification from the tenderer on the reason for the high tender price. The Procuring Entity shall proceed as follows:

- (i) If the tender price is abnormally high based on wrong estimated cost of the contract, the Procuring Entity may accept or not accept the tender

depending on the Procuring Entity's budget considerations.

- (ii) If specifications, scope of work and/or conditions of contract are contributory to the abnormally high tender prices, the Procuring Entity shall reject all tenders and may retender for the contract based on revised estimates, specifications, scope of work and conditions of contract, as the case may be.

40.3 If the Procuring Entity determines that the Tender Price is abnormally too high because genuine competition between tenderers is compromised (*often due to collusion, corruption or other manipulations*), the Procuring Entity shall reject all Tenders and shall institute or cause competent Government Agencies to institute an investigation on the cause of the compromise, before retendering.

41.0 Unbalanced and/or Front-Loaded Tenders

41.1 If in the Procuring Entity's opinion, the Tender that is evaluated as the lowest evaluated price is seriously unbalanced and/or front loaded, the Procuring Entity may require the Tenderer to provide written clarifications. Clarifications may include detailed price analyses to demonstrate the consistency of the tender prices with the scope of works, proposed methodology, schedule and any other requirements of the Tender document.

41.2 After the evaluation of the information and detailed price analyses presented by the Tenderer, the Procuring Entity may as appropriate:

- i. accept the Tender; or
- ii. require that the total amount of the Performance Security be increased at the expense of the Tenderer to a level not exceeding a 10% of the Contract Price; or
- iii. agree on a payment mode that eliminates the inherent risk of the Procuring Entity paying too much for undelivered works; or
- iv. reject the Tender,

42.0 Qualifications of the Tenderer

42.1 The Procuring Entity shall determine to its satisfaction whether the eligible Tenderer that is selected as having submitted the lowest evaluated cost and substantially responsive Tender, meets the qualifying criteria specified in Section III, Evaluation and Qualification Criteria.

42.2 The determination shall be based upon an examination of the documentary evidence of the Tenderer's qualifications submitted by the Tenderer, pursuant to ITT 17. The determination shall not take into consideration the qualifications of other firms such as the Tenderer's subsidiaries, parent entities, affiliates, subcontractors (other than Specialized Subcontractors if permitted in the Tender document), or any other firm(s) different from the Tenderer.

42.3 An affirmative determination shall be a prerequisite for award of the Contract to the Tenderer. A negative determination shall result in disqualification of the Tender, in which event the Procuring Entity shall proceed to the Tenderer who offers a substantially responsive Tender with the next lowest evaluated price to make a similar determination of that Tenderer's qualifications to perform satisfactorily.

43.0 Best Evaluated Tender

Having compared the evaluated prices of Tenders, the Procuring Entity shall determine the Lowest Evaluated Tender. The Lowest Evaluated Tender is the Tender of the Tenderer that meets the Qualification Criteria and whose Tender has been determined to be:

- a) Most responsive to the Tender document; and
- b) The lowest evaluated price.

44.0 Procuring Entity's Right to Accept Any Tender, and to Reject Any or All Tenders.

The Procuring Entity reserves the right to accept or reject any Tender and to annul the Tender process and reject all Tenders at any time prior to Contract Award, without there by incurring any liability to Tenderers. In case of annulment, all Tenders submitted and specifically, Tender securities, shall be promptly returned to the Tenderers.

F. AWARD OF CONTRACT

45.0 Award Criteria

45.1 The Procuring Entity shall award the Contract to the successful tenderer whose tender has been determined to be the Lowest Evaluated Tender.

46.0 Notice of Intention to enter into a Contract

46.1 Upon award of the contract and Prior to the expiry of the Tender Validity Period the Procuring Entity shall issue a Notification of Intention to Enter into a Contract/Notification of award to all tenderers which shall contain, at a minimum, the following information:

- i. the name and address of the Tenderer submitting the successful tender;
- ii. the Contract price of the successful tender;
- iii. a statement of the reason(s) the tender of the unsuccessful tenderer to whom the letter is addressed was unsuccessful, unless the price information in (c) above already reveals the reason;
- iv. the expiry date of the Standstill Period; and
- v. instructions on how to request a debriefing and/or submit a complaint during the stand still period;

47.0 Stand still Period

- 47.1 The Contract shall not be signed earlier than the expiry of a Standstill Period of 14 days to allow any dissatisfied tender to launch a complaint. Where only one Tender is submitted, the Standstill Period shall not apply.
- 47.2 Where a Standstill Period applies, it shall commence when the Procuring Entity has transmitted to each Tenderer the Notification of Intention to Enter into a Contract with the successful Tenderer.

48.0 Debriefing by the Procuring Entity

- 48.1 On receipt of the Procuring Entity's Notification of Intention to Enter into a Contract referred to in ITT 43, an unsuccessful tenderer may make a concern(s) regarding their tender. The Procuring Entity shall provide the debriefing within five days of receipt of the request.
- 48.2 Debriefings of unsuccessful Tenderers may be done in writing or verbally. The tenderer shall bear its own costs of attending such a debriefing meeting.

49.0 Letter of Award

- 49.1 Prior to the expiry of the Tender Validity Period and upon expiry of the Standstill Period specified in ITT 42.1, upon addressing a complaint that has been filed within the Standstill Period, the Procuring Entity shall transmit the Letter of Award to the successful Tenderer. The letter of award shall request the successful tenderer to furnish the Performance Security within 21 days of the date of the letter.

50.0 Signing of Contract

- 50.1 Upon the expiry of the fourteen days of the Notification of Intention to enter into contract and upon the parties meeting their respective statutory requirements, the Procuring Entity shall send the successful Tenderer the Contract Agreement.
- 50.2 Within fourteen (14) days of receipt of the Contract Agreement, the successful Tenderer shall sign, date, and return it to the Procuring Entity.
- 50.3 The written contract shall be entered into within the period specified in the notification of award and before expiry of the tender validity period.

51.0 Appointment of Adjudicator

- 51.1 The Procuring Entity proposes the person named in the TDS to be appointed as Adjudicator under the Contract, at the hourly fee specified in the TDS, plus reimbursable expenses. If the Tenderer disagrees with this proposal, the Tenderer should so state in his Tender. If, in the Letter of Acceptance, the Procuring Entity does not agree on the appointment of the Adjudicator, the Procuring Entity will request the Appointing Authority designated in the Special Conditions of Contract (SCC) pursuant to Clause 23.1 of the General

Conditions of Contract (GCC), to appoint the Adjudicator.

52.0 Performance Security

- 52.1 Within twenty-one (21) days of the receipt of the Letter of Award from the Procuring Entity, the successful Tenderer shall furnish the Performance Security and, any other documents required in the **TDS**, in accordance with the General Conditions of Contract, subject to ITT 38.2 (b), using the Performance Security and other Forms included in Section X, Contract Forms, or another form acceptable to the Procuring Entity. A foreign institution providing a bank guarantee shall have a correspondent financial institution located in Kenya, unless the Procuring Entity has agreed in writing that a correspondent bank is not required.
- 52.2 Failure of the successful Tenderer to submit the above-mentioned Performance Security and other documents required in the **TDS** or sign the Contract shall constitute sufficient grounds for the annulment of the award and forfeiture of the Tender Security. In that event the Procuring Entity may award the Contract to the Tenderer offering the next Best Evaluated Tender.
- 53.3 Performance security shall not be required for contract estimated to cost less than the amount specified in the Regulations.

53.0 Publication of Procurement Contract

- 53.1 Within fourteen days after signing the contract, the Procuring Entity shall publish the awarded contract at its notice boards and websites; and on the Website of the Authority. At the minimum, the notice shall contain the following information:
- a. name and address of the Procuring Entity;
 - b. name and reference number of the contract being awarded, a summary of its scope and the selection method used;
 - c. The name of the successful Tenderer, the final total contract price, the contract duration.
 - d. dates of signature, commencement and completion of contract;
 - e. Names of all Tenderers that submitted Tenders, and their Tender prices as read out at Tender opening.

54.0 Procurement Related Complaint

- 54.1 The procedures for making Procurement-related Complaints shall be specified in the **TDS**.
- 54.2 A request for administrative review shall be made in the form provided under contract forms.

SECTION III - TENDER DATA SHEET (TDS)

The following specific data for the Works and Services to be procured shall complement, supplement, or amend the provisions in the Instructions to Tenderers (ITT). Whenever there is a conflict, the provisions herein shall prevail over those in ITT.

ITT Reference	PARTICULARS OF APPENDIX TO INSTRUCTIONS TO TENDERS
	A. General
ITT 1.1	The name of the contract is PERIODIC MAINTENANCE OF ROADS IN NAMWELA WARD The reference number of the Contract is BGM/CNTY/RPW/CEF /OT/075/2025-2026 The number and identification of lots (contracts) comprising this tender are NOTAPPLICABLE
ITT 2.3	The Information made available on competing firms is as follows: NOT APPLICABLE
ITT 2.4	The firms that provided consulting services for the contract being tendered for are: NOT APPLICABLE
ITT 3.1	Maximum number of members in the Joint Venture NOT APPLICABLE
ITT 3.10	Foreign tenderers are required to source at least forty (40%) percent of their contract inputs (in supplies, subcontracts and labor) from national suppliers and contractors. NOTAPPLICABLE
B. Contents of Tender Document	
ITT 7.1	There SHALL BE NO pretender site visit.
ITT 8.1	(A) Pre-Tender conference <i>SHALL NOT</i> take place. Tenderers are to make their own arrangements to visit the projects sites/roads to appraise themselves of the site conditions before submitting their bids
ITT 8.2	i. The Tenderer will submit any questions in writing, to reach the Procuring Entity not later than 7 days before closure/opening date. ii. The Procuring Entity will publish the response at the Website www.bungoma.go.ke
ITT 8.4	The Procuring Entity's website where Minutes of the pre-Tender meeting and the pre-arranged pretender site visit will be published NOT APPLICABLE
ITT 9.1	For Clarification of Tender purposes, for obtaining further information and for purchasing tender documents, the Procuring Entity's address is: The Chief Officer, Department of Roads, Infrastructure and Public works P.O. Box 437 - 50200 BUNGOMA.
C. Preparation of Tenders	

ITT 13.1 (h)	The Tenderer shall submit the following additional documents in its Tender: <i>As indicated in the qualification criteria and Tender Notice</i>
ITT 13.2	The Tenderer shall chronologically and sequentially serialize all pages of the Tender Documents submitted in the format of 1, 2, 3, 4, 5..... Including the cover page and All other pages.
ITT Reference	PARTICULARS OF APPENDIX TO INSTRUCTIONS TO TENDERS
ITT 15.1	Alternative Tenders SHALL NOT be permitted
ITT 15.2	Alternative times for completion SHALL NOT permitted.
ITT 15.4	Alternative technical solutions SHALL NOT be permitted.
ITT 16.5	The prices quoted by the Tenderer shall be: FIXED
ITT 17.1	The currency(ies) of the Tender and the payment currency(ies) shall be as described below: (a) The unit rates and the prices shall be quoted by the Tenderer in the Bill of Quantities, entirely in Kenya Shillings.
ITT 20.1	The Tender validity period shall be 90 days.
ITT 21.1	A Tender-Securing Declaration SHALL BE required.
ITT 21.2 (d)	The other Tender Security shall NOT BE APPLICABLE
ITT 21.5	On the Performance Security, other documents required shall be: NOT APPLICABLE
ITT 22.1	Manual submission shall be done through the Tender Box at the County Headquarters
ITT 22.2	The written confirmation of authorization to sign on behalf of the Tenderer shall consist of Certificate of Independent Tender Determination

D. Submission and Opening of Tenders	
ITT 24.1	(A) For <u>Tender submission purposes</u> only, the Procuring Entity's address is: Name of Procuring Entity: COUNTY GOVERNMENT OF BUNGOMA Postal Address:... P.O. Box 437 - 50200. Physical address..... County Headquarters – Supply Chain Management Offices Opposite Municipal Building).....
	The Tender opening shall take place at the time and the address for Opening of Tenders provided below: Name of Procuring Entity: COUNTY GOVERNMENT OF BUNGOMA. Physical address: County Headquarters – Supply Chain Management Offices Opposite Municipal Building)..... Date: 28TH MAY 2026 Time: 11.00A.M
ITT Reference	PARTICULARS OF APPENDIX TO INSTRUCTIONS TO TENDERS
E. Evaluation, and Comparison of Tenders	
ITT 32.3	The adjustment shall be based on the average price of the item or component as quoted in other substantially responsive Tenders. If the price of the item or component cannot be derived from the price of other substantially responsive Tenders, the Procuring Entity shall use its best estimate. NOT APPLICABLE
ITT 35.2	The invitation to tender is extended to bidders as indicated in the Tender Notice.
ITT 36.1	At this time, the Procuring Entity <i>DOES NOT INTEND</i> to execute certain specific parts of the Works by subcontractors selected in advance.
ITT 36.3	The parts of the Works for which the Procuring Entity permits Tenderers to propose Specialized Subcontractors are designated as follows: NOT APPLICABLE
ITT 37.2 (d)	Additional requirements apply. These are detailed in the evaluation criteria in Section III, Evaluation and Qualification Criteria.
ITT 51.1	The Adjudicator SHALL APPLY.

ITT 54.1	<p>The procedures for making a Procurement-related Complaint are available from the PPRA website info@ppra.go.ke or complaints @ppra.go.ke. If a Tenderer wishes to make a Procurement-related Complaint, the Tenderer should submit its complaint following these procedures, in writing (by the quickest means available, that is either by hand delivery or email to:</p> <p>For the attention: <i>County Secretary</i> Procuring Entity: <i>County Government of Bungoma</i> Email address: <i>www.bungoma.go.ke</i></p> <p>In summary, a Procurement-related Complaint may challenge any of the following:</p> <p>(i) the terms of the Tender Documents; and</p> <p>(ii) the Procuring Entity's decision to award the contract.</p>
----------	--

SECTION IV- EVALUATION AND QUALIFICATION CRITERIA**General Provisions****1.0 General Provisions**

- 1.1 This section contains the criteria that the Employer shall use to evaluate tender and qualify tenderers. No other factors, methods or criteria shall be used other than specified in this tender document. The Tenderer shall provide all the information requested in the forms included in Section IV, Tendering Forms. The Procuring Entity shall use **the Standard Tender Evaluation Document for Goods and Works** for evaluating Tenders.
- 1.2 Wherever a Tenderer is required to state a monetary amount, Tenderers should indicate the Kenya Shilling equivalent using the rate of exchange determined as follows:
- (a) For construction turnover or financial data required for each year - Exchange rate prevailing on the last day of the respective calendar year (in which the amounts for that year is to be converted) was originally established.
 - (b) Value of single contract - Exchange rate prevailing on the date of the contract signature. Exchange rates shall be taken from the publicly available source identified in the ITT 14.3.
 - (c) Any error in determining the exchange rates in the Tender may be corrected by the Procuring Entity.

1.3 Evaluation and contract award Criteria

The Procuring Entity shall use the criteria and methodologies listed in this Section to evaluate tenders and arrive at the Lowest Evaluated Tender. The tender that

- (i) meets the qualification criteria,
- (ii) has been determined to be substantially responsive to the Tender Documents, and
- (iii) is determined to have the Lowest Evaluated Tender price shall be selected for award of contract.

2.0 Preliminary examination for Determination of Responsiveness

The Procuring Entity will start by examining all tenders to ensure they meet in all respects the eligibility criteria and other requirements in the ITT, and that the tender is complete in all aspects in meeting the requirements of “*Part 2 – Procuring Entity's Works Requirements*”, including checking for tenders with unacceptable errors, abnormally low tenders, abnormally high tenders

and tenders that are front loaded. The Standard Tender Evaluation Report for Goods and Works for evaluating Tenders provides clear guidelines on how to deal with review of these requirements. Tenders that do not pass the Preliminary Examination will be considered irresponsive and will not be considered further.

[The Procuring Entity will provide the preliminary evaluation criteria. To facilitate, a template may be attached or clearly described all information and list of documentation to be submitted by Tenderers to enable preliminary evaluation of the Tender]

3.0 Tender Evaluation (ITT 35)

Price evaluation: In addition to the criteria listed in ITT 35.2 (a) – (d) the following criteria shall apply:

- a. **Alternative Completion Times**, if permitted under ITT 13.2, will be evaluated as follows:N/A.....
- b. **Alternative Technical Solutions** for specified parts of the Works, if permitted under ITT 13.4, will be evaluated as follows:N/A.....
- c. **Other Criteria;** if permitted under ITT 35.2(d):N/A.....

4.0 Multiple Contracts

4.1 Multiple contracts will be permitted in accordance with ITT 35.4. Tenderers are evaluated on basis of Lots and the lowest evaluated tenderer identified for each Lot. The Procuring Entity will select one Option of the two Options listed below for award of Contracts.

OPTION 1

If a tenderer wins only one Lot, the tenderer will be awarded a contract for that Lot, provided the tenderer meets the Eligibility and Qualification Criteria for that Lot.

If a tenderer wins more than one Lot, the tender will be awarded contracts for all won Lots, provided the tenderer meets the aggregate Eligibility and Qualification Criteria for all the Lots. The tenderer will be awarded the combination of Lots for which the tenderer qualifies and the others will be considered for award to second lowest the tenderers.

OPTION 2

The Procuring Entity will consider all possible combinations of won Lots [contract(s)] and determine the combinations with the lowest evaluated price. Tenders will then be awarded to the Tenderer or Tenderers in the combinations provided the tenderer meets the aggregate Eligibility and Qualification Criteria for all the won Lots.

5.0 Alternative Tenders (ITT 13.1)

An alternative if permitted under ITT 13.1, will be evaluated as follows:

The Procuring Entity shall consider Tenders offered for alternatives as specified in Part2-Works Requirements. Only the technical alternatives, if any, of the Tenderer with the Best Evaluated Tender conforming to the basic technical requirements shall be considered by the Procuring entity.

6.0 Margin of Preference

- 6.1 If the TDS so specifies, the Procuring Entity will grant a margin of preference of fifteen percent (15%) to be loaded one valuated price of the foreign tenderers, where the percentage of shareholding of Kenyan citizens is less than fifty-one percent (51%).
- 6.2 Contractors applying for such preference shall be asked to provide, as part of the data for qualification, such information, including details of ownership, as shall be required to determine whether, according to the classification established by the Procuring Entity, a particular contract or group of contractors qualifies for a margin of preference.
- 6.3 After Tenders have been received and reviewed by the Procuring Entity, responsive Tenders shall be assessed to ascertain their percentage of shareholding of Kenyan citizens. Responsive tenders to shall be classified into the following groups:
- (i) Group A: tenders offered by Kenyan Contractors and other Tenderers where Kenyan citizens hold shares of over fifty-one percent (51%).
 - (ii) Group B: tenders offered by foreign Contractors and other Tenderers where Kenyan citizens hold shares of less than fifty-one percent (51%).
- 6.4 All evaluated tenders in each group shall, as a first evaluation step, be compared to determine the lowest tender, and the lowest evaluated tender in each group shall be further compared with each other. If, as a result of this comparison, a tender from Group A is the lowest, it shall be selected for the award. If a tender from Group B is the lowest, an amount equal to the percentage indicated in Item 3.1 of the respective tender price, including unconditional discounts and excluding provisional sums and the cost of day works, if any, shall be added to the evaluated price offered in each tender from Group B. All tenders shall then be compared using new prices with added prices to Group Band the lowest evaluated tender from Group A. If the tender from Group A is still the lowest tender, it shall be selected for award. If not, the lowest evaluated tender from Group B based on the first evaluation price shall be selected.

7.0 Post qualification and Contract award (ITT 39), more specifically,

- a. In case the tender was subject to post-qualification, the contract shall be awarded to the

- lowest evaluated tenderer, subject to confirmation of pre-qualification data, if so required.
- b. In case the tender was not subject to post-qualification, the tender that has been determined to be the lowest evaluated tenderer shall be considered for contract award, subject to meeting each of the following conditions.
- (i) The Tenderer shall demonstrate that it has access to, or has available, liquid assets, unencumbered real assets, lines of credit, and other financial means (independent of any contractual advance payment) sufficient to meet the construction cash flow of Kenya Shillings.
 - (ii) Minimum average annual construction turnover of Kenya Shillings [*insert amount*], equivalent calculated as total certified payments received for contracts in progress and/or completed within the last [*insert of year*] years.
 - (iii) At least(*insert number*) of contract(s) of a similar nature executed within Kenya, or the East African Community or abroad, that have been satisfactorily and substantially completed as a prime contractor, or joint venture member or sub-contractor each of minimum value Kenya shillingsequivalent.
 - (iv) Contractor's Representative and Key Personnel, which are specified as____
 - (v) Contractors key equipment listed on the table “Contractor's Equipment” below and more specifically listed as [*specify requirements for each lot as applicable*]____
 - (vi) Other conditions depending on their seriousness.

c) History of non-performing contracts:

Tenderer and each member of JV in case the Tenderer is a JV, shall demonstrate that Nonperformance of a contract did not occur because of the default of the Tenderer, or the member of a JV in the last 2(*specify years*). The required information shall be furnished in the appropriate form.

d) Pending Litigation

Financial position and prospective long-term profitability of the Single Tenderer, and in the case the Tenderer is a JV, of each member of the JV, shall remain sound according to criteria established with respect to Financial Capability under Paragraph (i) above if all pending litigation will be resolved against the Tenderer. Tenderer shall provide information on pending litigations in the appropriate form.

e) Litigation History

There shall be no consistent history of court/arbitral award decisions against the Tenderer, in **the** last (*specify years*). All parties to the contract shall furnish the information in the appropriate form about any litigation or arbitration resulting from contracts completed or ongoing under its execution over the years specified. A consistent history of awards against the Tenderer or any member of a JV may result in rejection of the tender.

SECTION IV: EVALUATION AND QUALIFICATION CRITERIA CONTD...

This Section contains all the factors, methods and criteria that the Employer shall use to evaluate applications. The information to be provided in relation to each factor and the definitions of the corresponding terms are included in the respective Application Forms.

- 1) Eligibility Requirements
- 2) Historical Contract Non-Performance
- 3) Financial Situation
- 4) Technical/Engineering Works Experience
- 5) Program of Works and Work Methodology
- 6) Key Professional and Technical Site Staff
- 7) Major Plant and Equipment to be used in the Project

B. TECHNICAL EVALUATION

Item No.	Qualification Subject	Qualification Requirement	Document to be Completed/provided by Tenderer	For Procuring Entity's Use (Qualification met or Not Met)
1	History of Non - performing contracts	Non-performance of a contract did not occur as a result of contractor default for the last three (3) years. did not occur as a result of contractor default for the last three (3) years. On-performance shall be deemed to have occurred by evidence of: Termination Letter and Liquidated damages	Form CON-1 If a bidder fails to disclose, shall be disqualified Reference to be made to procuring Authority's records. A bidder with any history of non-performance earns zero(0) marks	5 Marks
2	Financial Capabilities	(i) Bidders shall provide audited balance sheets or, if not required by the laws of the Tenderer's country, other financial statements acceptable to the Procuring Entity, for the last 3 years shall be submitted and must demonstrate the current soundness of the Tenderer's financial position and indicate its prospective long-term profitability (as demonstrated by Financial Evaluation ratios).	Form FIN - 3.1, with attachments. i. Audited accounts All pages must be initialed and stamped by both a practicing Auditor registered with ICPAK and one of the Directors. Auditor's practicing membership number from ICPAK must be indicated and a valid practicing license shall be provided. The Financial Ratio Form to be signed by the Auditor registered with ICPAK and one of the Directors · Financial Ratios	8 Marks

		<p>Computation shall be made for the following Ratios and marks awarded to each of the ratios:</p> <p>Working Capital</p> <p>Debt to Equity Ratio</p> <p>Current ratio</p> <p>Operating Cash Flow ratio</p>	4 Marks
	<p>(ii) The Tenderer shall demonstrate that it has access to, or has available, liquid assets, unencumbered real assets, lines of credit, and other financial means (independent of any contractual advance payment) sufficient to meet the construction cash flow requirements estimated at a minimum of 10% of Engineer's</p> <p>The Tenderers shall also demonstrate, to the satisfaction of the Procuring Entity, that it has adequate sources of finance to meet the cash flow requirements on works currently in progress and for future contract commitments.</p>	Line of credit and Bank Statements	2 Marks

3	Average Annual Construction Turnover	Minimum average annual construction turnover of Kenya Shillings Fifteen Million (20,000,000), equivalent calculated as total certified payments received for contracts in progress and/or completed within the last 3 years, divided by 3 years	Form FIN - 3.2 Attachments include Financial Statements	1 Marks
4	Ongoing Works	Value of outstanding works shall not be more than the Engineer`s Estimate Experience under construction contracts in the role of prime contractor, JV member, subcontractor, or management contractor, substantially completed in the last [5 years] prior to the applications submission deadline.	Form FIN - 3.4 If the outstanding Works is more than the Engineer`s Estimate of this bid, the bidder loses 2marks	2marks
5	General Construction Experience	Experience under construction contracts in the role of prime contractor, JV member, subcontractor, or management contractor, substantially completed in the last [3 years] prior to the applications submission deadline.	Form EXP -4.1 Attach Letters of Award and Completion Certificates	6 Marks (2 Marks for each General Construction project)

6	Specific Construction and Contract Management Experience	Participation in contract (s) of a similar nature with minimum cumulative value of <i>Five Million (Kshs.5,000,000)</i> as filled in Form EXP 4.2(a) that have been satisfactorily and substantially completed by the bidder, as a prime contractor, joint venture member, management contractor or subcontractor in the last [5 years] prior to the applications submission deadline. The similarity shall be based on the physical size, complexity, methods/technology or other	Form EXP 4.2(a)&(b) Provide Letters of Award and Completion Certificates <ul style="list-style-type: none"> • Award letter of the main contractor • Award letter of the subcontract. • Completion letter of the subcontract. • Subcontract approval from the Engineer/supervision Authority 	2 Marks
7	Contractor's Representative and Key Personnel	Curriculum Vitae (CVs) of the Proposed Key Staff must be presented in the provided format and duly signed by the proposed individual. Copies of certificates and Annual Practicing Licenses (for Engineers) and Academic Certificates for all staff is mandatory;	Schedule F (Form PER. 1 and PER. 2)	30Marks

8	Contractors key equipment	<p>· Bidders shall declare they have possession/Ownership/lease agreements of various equipment as proposed to be used in the Project by providing Logbooks that demonstrate proof of ownership</p>	<p>Motor Grader – 3Mks Excavator – 3mks Lorry Tippers – 6mks (Minimum of 3) Single drum roller – 3mks</p>	15 Marks
9	Work methodology	<p>Adequacy and quality of the proposed methodology</p>	<p>Provided a detailed Work Methodology: Procedure on execution of activities as outlined in the BoQs Allocation of machinery/labour in xecution the activities Procedures in quality control of the activities described in BoQs</p> <p>Work plan/Program of Works (PoW)</p> <ul style="list-style-type: none"> • PoW Resourced with Equipment-Min. allocation pursuant to the Schedule E of Technical Proposal - – To be submitted in A3 Size Paper well legible Fonts • PoW details BoQ Quantities, Units and Rates <p>PoW is superimposed with Cash Flow Projections as detailed in Schedule A of the technical proposal</p>	20 Marks

10	Work Safety management	Proposals on traffic control, workers' safety & accident prevention		10 Marks
----	------------------------	---	--	----------

C. FINANCIAL EVALUATION:

The lowest evaluated bidder shall be subjected to Financial Evaluation which include but not limited to **sensitivity analysis** of the **rates to detect abnormally low bids or abnormally high bids or unbalanced tenders or front loaded**.

Treatment of Abnormally Low Bid/Abnormally high Bid/ Unbalanced bid

The Procuring Entity may undertake an analysis of bidders' rates which are potentially lower/higher than the known prevailing market rates. The bidders shall be required to provide objective justification including supporting documents on derivation of their rates within stipulated time to the Procuring Entity (*See Schedule G, Part I&II on Derivation of Rates*).

In addressing the above criteria, the following steps shall be undertaken by the Procuring Entity;

Identify: The Procuring Entity identifies a potential Abnormally Low/High Bid based on comparison with known prevailing market rates or with the project's total cost estimate.

- a. **Evaluate:** The Procuring Entity clarifies with the Bidder/proposer (hereafter the Bidder). The Bidder prepares a justification of their price based on the request from the Procuring Entity. The procuring Entity fully analyzes the Bidder's justification to verify if it is an Abnormally Low/High Bid. Due diligence may be carried out by the Procuring Entity on the bidder's documentation.
- b. **Determination:** The Procuring Entity fully documents the decision to accept or reject the Bid and executes appropriate action(s)/recommendation(s).

In view of the above, the procuring Entity shall evaluate and analyze the Bidders' submissions against the known prevailing market rates and cost estimation guidelines. The analysis of the bidder's justification shall take into account all evidence provided in response to the request.

Accordingly, the Procuring Entity's relevant committee shall make a recommendation to the Accounting Officer.

D. POST QUALIFICATION: The procuring entity may verify the documents provided by the bidder with the issuing authority.

APPENDIX TO THE QUALIFICATION CRITERIA

ITEM	DESCRIPTION			POINT SCORE SCALE
1	History of Non - Performance			Max 5
2	KEY PERSONNEL			Max 30
	Site Agent (Max 14 marks)	Qualification	Bsc Civil Engineering.	8
			Registered Engineer	3
			HND in Civil Eng.	4
			Dip in Civil Eng.	3
		Experience	> 8 years and above	3
			3-7 years	2
	0 -2 years		1	
	Surveyor (Max 8 marks)	Qualification	Diploma in Survey (Minimum)	5
			Certificate in Survey	2
		Experience	> 6 Years	3
			3 – 5 Years	2
			0-3Years	1
	Foreman (Max 8marks)	Qualification	Diploma in Civil Engineering (Minimum)	5
			Certificate in Civil Engineering	2
Experience		> 6 Years	3	
		3 – 5 Years	2	
		0-3Years	1	
2	PLANT AND EQUIPMENT			Max 15

	Single Drum Roller self-propelled - 1No.	Owned	3
		Leased	2
	Motor Grader	Owned	3
		Leased	2
	Hydraulic excavator CAT 180HP or equivalent – 1No.	Owned	3
		Leased	2
	Tipper Trucks 15 ton gross capacity – 3No.	Owned	6
		Leased	4.5
3	FINANCIAL CAPABILITY		Max 15
	Financial statements	The financial accounts, balance sheets, profit and loss statements are certified by reputable audit firm. Contact information of the firm to be provided (Last three Years)	6
		Auditor’s practicing Membership Number by ICPAK indicated and valid practicing license attached.	2
		The Bank statements are from a reputable Bank. Contact information to be availed (Last Six Months)	1
		Computations for the following financial ratios from the latest audited accounts: <ul style="list-style-type: none"> • Working capital Ratio • Debt to Equity Ratio • Current Ratio • Operating cash flow Ratio 	2
	Financial Information / Current work	Provide average turn-over figures for the last three (3) years showing current work commitment.	1
		Provide undertaking from the bank providing current line of credit specific to the tender	1

	On going works		2
4	WORK METHODOLOGY		Max 20
		Signed work programme chart and cash flow estimate	0-10
		Detailed method statement on how to carry out the intended works	0-10
5	WORK SAFETY MANAGEMENT		Max 10
	Proposals on traffic control, workers' safety & accident prevention		10
7	EXPERIENCE		Max 5
	General Experience (Attach Letters of Award and Completion Certificates for each project for the last 3 years)		3
	Two (2 No) of projects submitted above, should have a minimum Contract value of Kshs. 5,000,000 and similar in nature with this tender		2
	TOTAL		MAX 100

1. CONTRACTOR'S EQUIPMENT.

The Bidder shall indicate the core plant and equipment considered by the company to be necessary for undertaking the project together with proof of ownership or lease of the same. The lease must be recurrent i.e. should for FY 2023-2024. Leases which are out dated will not be accepted. (* Mandatory minimum number of equipment required by the Employer for the execution of the project that the bidder shall make available for the Contract).

Item No.	Equipment Details	Ideal Number Required for the Contract Execution	No. of Equipment Owned by the Bidder	No. of equipment to be hired/purchased by the Bidder	No. of equipment to be made available for the Contract by the Bidder	Date of Arrival on Project (Days after commence)
	A) Concrete Equipment					
	(i) Mobile concrete mixers	1				
	(ii) Concrete vibrators	1				
	B) Transport (Tippers, dumpers, water tankers)					
	(i) 6 X 4 tippers payload 16 – 20 tones	3				
	(ii) Water tankers (18,000 – 20,000 lts. capacity)	1				
	C) Earth – Moving Equipment					
	(i) Wheeled loaders					
	(ii) Motor graders (93 - 205kW)	1				
	D) Excavators					
	1. Hydraulic crawler mounted (7 – 10 tonnes) – 0.25 – 0.4 m ³ SAE bucket.	1				
	E) Rollers					

	(i) Self-propelled single drum vibrating (various types) (ii) Self-propelled double drum vibrating (various types)	1 -				
Item No.	Equipment Details	Ideal Number Required for the Contract Execution	No. of Equipment Owned by the Bidder	No. of equipment to be hired/purchased by the Bidder	No. of equipment to be made available for the Contract by the Bidder	Date of Arrival on Project (Days after commence)
	(iii) Pneumatic Roller	0				
	F) F) Others					
	(i) Paver (ii) Pot hole cutter (iii) Hand sprayer (iv) Pedestrian Roller	0 - -				

I certify that the above information is correct.

Signature of Tenderer:Date:

QUALIFICATION FORMS

1.0 Foreign Tenderers 40% rule

3. FORM EQU: EQUIPMENT

The Tenderer shall provide adequate information to demonstrate clearly that it has the capability to meet the requirements for the key equipment listed in Section III, Evaluation and Qualification Criteria. A separate Form shall be prepared for each item of equipment listed, or for alternative equipment proposed by the Tenderer.

Item of Equipment		
Equipment Information	Name of Manufacturer	Model and Power Rating
	Capacity	Year of Manufacture
Current Status	Current Location	
	Current commitments	
Source	Indicate source of Equipment	
	<input type="checkbox"/> Owned <input type="checkbox"/> Rented <input type="checkbox"/> Leased <input type="checkbox"/> Specially manufactured	
Owner	Name of Owner	
	Address of Owner	
	Telephone	Contact Name and Title
	Fax	Telex
Agreements	Details of rental / lease / manufacture agreements specific to the project	

3. FORMPER-1

**Contractor's Representative and
Key Personnel Schedule**

Tenderers should provide the names and details of the suitably qualified Contractor's Representative and Key Personnel to perform the Contract. The data on their experience should be supplied using the Form PER-2 below for each candidate.

1	Title of Position: Contractor's Representative	
	Name of Candidate:	
	Duration of appointment:	
	Time Commitment for this position	
	Expected time schedule for this position	
2	Title of Position:	
	Name of Candidate:	
	Duration of appointment:	
	Time Commitment for this position	
	Expected time schedule for this position	
3	Title of Position:	
	Name of Candidate:	
	Duration of appointment:	
	Time Commitment for this position	
	Expected time schedule for this position	
4	Title of Position:	
	Name of Candidate:	
	Duration of appointment:	
	Time Commitment for this position	

4. FORMPER-2

Resume and declaration – Contractor’s Representative and Key Personnel

Name of Tenderer		
Position [As per Form Per1]		
Personal Information	Name:	Date of Birth:
	Address:	Email:
	Professional Qualifications	
	Academic Qualifications	
	Language proficiency (<i>Language and levels of speaking, reading and writing skills</i>)	
Details	Address of procuring entity	
	Telephone	Contact (Manager or Personnel officer)
	Fax	Email Address
	Job Title	Years with the Procuring Entity

Summarize professional experience in reverse chronological order. Indicate particular technical and managerial experience relevant to the project

Project	Role	Duration of involvement	Relevant Experience
<i>[Main Project Details]</i>	<i>[Roles and Responsibilities on</i>	<i>[Time in Role]</i>	<i>[Describe the experience relevant to this project]</i>

	<i>the Project]</i>		

DECLARATION

I, the under signed [*insert either “Contractor's Representative” or “Key Personnel” as applicable*], certify that to the best of my knowledge and belief, the information contained in this Form PER-2 correctly describes myself, my qualifications and my experience.

I confirm that I am available as certified in the following table and throughout the expected time schedule for this position as provided in the Tender:

Commitment	Details
Commitment to duration of contract:	
Time Commitment	

I understand that any misrepresentation or omission in this Form may:

- a) be taken into consideration during Tender evaluation;
- b) result in my disqualification from participating in the Tender;
- c) result in my dismissal from the contract.

Name of Contractor's Representative or Key Personnel: [*insert name*]

Signature:..... Date: (Day, Month, Year):.....

Countersignature of authorized representative of the Tenderer:

Signature:..... Date: (Day, Month, Year):.....

TENDERERS QUALIFICATION WITHOUT PREQUALIFICATION

To establish its qualifications to perform the contract in accordance with Section III, Evaluation and Qualification Criteria the Tenderer shall provide the information requested in the corresponding Information Sheets included hereunder.

6.1 FORMELI – 1.1 TENDERER INFORMATION FORM

DATE:.....

ITT NO. AND TITLE:.....

Tenderer’s Name:.....
In case of Joint Venture, Name of each Member:
Tenderer’s actual or intended country of registration:
Tenderer’s actual or intended year of Incorporation:
Tenderer’s Legal address (In country of registration):
Tenderer’s Authorized representative information: Name:..... Address:..... Telephone / Fax Numbers:..... Email address:.....
1. Attached copies of original documents of: <ul style="list-style-type: none">• Articles of Incorporation (or equivalent documents of constitution or Association) and or documents of registration of the legal entity named above in accordance ITT3.6• In case of JV, letter of intent to form JV or agreement in accordance with ITT3.5• In case of state owned enterprise or institution in accordance with ITT3.8, documents establishing
2. Included are the organizational chart, a list of Board of Directors and the beneficial ownership

6.2 FORMELI – 1.2 TENDERER JV INFORMATION FORM

(To be completed by each member of JV)

DATE:.....

ITT NO. AND TITLE:.....

Tenderer’s Name:.....	JV
JV Member’s Name:.....	Name:
JV Member’s country of registration:.....	
JV Member’s constitution:.....	Year of
JV Member’s legal address in the Country of Constitution:.....	
Tenderer’s Authorized representative information: Name:.....	
Telephone / Fax Numbers:.....	
Email address:.....	
<p>1. Attached copies of original documents of:</p> <ul style="list-style-type: none"> • Articles of Incorporation (or equivalent documents of constitution or Association) and or documents of registration of the legal entity named above in accordance ITT43.6 • In case of state owned enterprise or institution, documents establishing legal and financial autonomy operation in accordance with commercial law and they are not under the supervision of the procuring entity in accordance with ITT3.8 <p>2. Included are the organizational chart, a list of Board of Directors and the beneficial ownership</p>	

6.3 FORM CON - 2

TENDERER'S NAME.....

DATE:.....

JV MEMBER'S NAME.....

ITT NO. AND TITLE:.....

Non – Performance Contracts in accordance with Section III, Evaluation and Qualification Criteria			
<input type="checkbox"/> Contract non – performance did not occur since 1 st January 2020 specified in Section III, Evaluation and Qualification Criteria, Sub Factor 2.1			
<input type="checkbox"/> Contract(s) not performed since 1 st January 2020 specified in Section III, Evaluation and Qualification Criteria, requirement 2.1			
Year <i>(Insert year)</i>	Non – Performed portion of contract <i>(Insert amount and percentage)</i>	Contract Identification <i>(Indicate complete contract name/number and any other identification)</i> <i>Name of Procuring Entity</i> <i>Address of Procuring Entity</i> <i>Reasons for non-performance</i>	Total Contract Amount (Current value, currency, exchange rate and Kenya Shilling equivalent)
Pending Litigation, in accordance with Section III, Evaluation and Qualification Criteria			
<input type="checkbox"/> No pending litigation in accordance with Section III, Evaluation and Qualification Criteria, sub factor 2.3			
<input type="checkbox"/> Pending litigation in accordance with Section III, Evaluation and Qualification Criteria, sub factor 2.3 as indicated below			
Year of dispute	Amount in dispute (currency)	Contract Identification	Total Contract Amount (currency), Kenya Shilling Equivalent (exchange rate)
		Contract Identification: _____ Name of Procuring Entity Address of Procuring Entity: Matter in dispute: _____ _____ Party who initiated the dispute: Status of dispute: _____	
		Contract Identification:	

		Name of Procuring Entity: Address of Procuring Entity: Matter in dispute: Party who initiated the dispute: Status of dispute:	
Litigation History in accordance with Section III, Evaluation and Qualification Criteria			
<input type="checkbox"/> No Litigation history in accordance with Section III, Evaluation and Qualification Criteria, sub factor 2.4			
<input type="checkbox"/> Litigation History in accordance with Section III, Evaluation and Qualification Criteria, sub factor 2.4 as indicated below			
Year of dispute	Amount in dispute (currency)	Contract Identification	Total Contract Amount (currency), Kenya Shilling Equivalent (exchange rate)
		Contract Identification: _ _ _ _ _ Name of Procuring Entity: _____ _____ _ Address of Procuring Entity: _____ _____ _ Matter in dispute: _ _ _ _ _ Party who initiated the dispute: Status of dispute: _____	
		Contract Identification: Name of Procuring Entity: Address of Procuring Entity: Matter in dispute: Party who initiated the dispute: Status of dispute:	

.....

Signature and Stamp of Bidder

.....

(Date)

6.4 FORM FIN – 3.1

Financial situation and performance

TENDERER’S NAME.....

DATE.....

JV MEMBER’S NAME.....

ITT NO. AND TITLE.....

6.4.1 Financial data

Type of Financial information in _____ (currency)	Historic information for previous _____ years, _____ (amount in currency, currency, exchange rate*, USD equivalent)				
	Year 1	Year 2	Year 3	Year 4	Year 5
Statement of Financial Position (Information from Balance Sheet)					
Total Assets (TA)					
Total Liabilities (TL)					
Total Equity/Net Worth (NW)					
Current Assets (CA)					
Current Liabilities (CL)					
Working Capital (WC)					
Information from Income Statement					
Total Revenue (TR)					
Profits Before Taxes (PBT)					
Cash Flow Information					
Cash Flow from Operating Activities					

6.4.2 Sources of Finance

Specify sources of finance to meet the cash flow requirements on works currently in progress and for future contract commitments.

No.	Source of finance	Amount (Kenya Shilling equivalent)
1		
2		
3		

6.4.3 Financial Statements

The Tenderer and its parties shall provide copies of financial statements for _____ years pursuant Section III, Evaluation and Qualifications Criteria, Sub-factor 3.1. The financial statements shall:

- a) reflect the financial situation of the Tenderer or in case of JV member, and not an affiliated entity (such as parent company or group member).
- b) be independently audited or certified in accordance with local legislation.
- c) be complete, including all notes to the financial statements.
- d) correspond to accounting periods already completed and audited.

Attached are copies of financial statements for the years required above; and complying with the requirements

6.5 FORM FIN – 3.2
Average Annual Construction Turnover

Annual Turnover Data (Construction Only)			
Year (<i>Indicate year</i>)	Amount and Currency (insert amount and indicate currency)	Exchange Rate	Kenya Shilling Equivalent
Average Annual Construction Turnover			

**6.6 FORM FIN – 3.3
Financial Resources**

Specify proposed sources of financing, such as liquid assets, unencumbered real assets, lines of credit, and other financial means, net of current commitments, available to meet the total construction cashflow demands of the subject contractor contracts as specified in Section III, Evaluation and Qualification Criteria.

No.	Source of finance	Amount (Kenya Shilling equivalent)
1		
2		
3		

6.7 FORM FIN – 3.4

Current Contract Commitments / Works in Progress

No.	Name of Contract	Procuring Entity's Contact Address, Tel,	Value of Outstanding Work [Current Kenya Shilling /month Equivalent]	Estimated Completion Date	Average Monthly Invoicing Over Last Six Months [Kenya Shilling /month]
1					
2					
3					
4					
5					

**6.8 FORM EXP – 4.1
General Construction Experience**

TENDERER’S NAME.....

DATE.....

JV MEMBER’S NAME.....

ITT NO. AND TITLE.....

Starting Year	Ending Year	Contract Identification	Role of Tenderer
		Contract Name..... Brief Description of the works performed by the Tenderer Amount of Contract Name of Procuring Entity Address 	
		Contract Name..... Brief Description of the works performed by the Tenderer	

		<p>.....</p> <p>.....</p> <p>Amount of Contract</p> <p>.....</p> <p>Name of Procuring Entity</p> <p>.....</p> <p>Address</p> <p>.....</p>	
		<p>Contract Name.....</p> <p>Brief Description of the works performed by the Tenderer</p> <p>.....</p> <p>.....</p> <p>.....</p> <p>Amount of Contract</p> <p>.....</p> <p>Name of Procuring Entity</p> <p>.....</p> <p>Address</p> <p>.....</p>	

**FORM – 4.2(b)
Construction Experience in Key Activities**

TENDERER’S NAME.....

DATE.....

JV MEMBER’S NAME.....

SUB CONTRACTOR’S NAME (AS PER ITT34)
ITT NO. AND

TITLE.....

All Sub-contractors for key activities must complete the information in this form as per ITT 34 and Section III, Evaluation and Qualification Criteria, Sub-Factor 4.2.

1. KEY ACTIVITY ONE:.....

Similar Contract No.	Information			
Contract Identification				
Award Date				
Completion Date				
Role in Contract	Prime Contractor	Member in JV	Management Contractor	Sub-Contractor
Total Contract Amount				Kenyan Shilling
Quantity (Volume, number or rate of production as applicable) performed under the contract per year or part or part of the year.	Total quantity in contract (i)	Percentage participation (ii)	Actual quantity performed (i) x (ii)	
Year 1				
Year 2				
Year 3				

Year 4			
Procuring Entity's Name			
Address: Telephone / Fax Number: Email:			
Description of the key activities in accordance with sub factor 4.2(b) of section III			

- 2. Activity Two.....**
- 3. Activity Three.....**

OTHER FORMS

FORM OF TENDER

INSTRUCTIONS TO TENDERERS

- i) *The Tenderer must prepare this Form of Tender on stationery with its letterhead clearly showing the Tenderer's complete name and business address.*
- ii) *All italicized text is to help Tenderer in preparing this form.*
- iii) *Tenderer must complete and sign CERTIFICATE OF INDEPENDENT TENDER DETERMINATION and the SELF DECLARATION OF THE TENDERER attached to this Form of Tender.*
- iv) *The Form of Tender shall include the following Forms duly completed and signed by the Tenderer.*
 - *Tenderer's Eligibility-Confidential Business Questionnaire.*
 - *Certificate of Independent Tender Determination.*
 - *Self-Declaration of the Tenderer.*

Date of this Tender submission:[insert date (as day, month and year) of Tender submission] **Request for Tender No.:**..... [insert

Name and description of Tender

..... [Insert as per

ITT) Alternative No.:..... [insert identification No if this is a Tender for an alternative]

To:.....

(Insert Complete Name of Procuring Entity)

Dear Sirs,

1. In accordance with the Conditions of Contract, Specifications, Drawings and Bills of Quantities for the execution of the above named Works, we, the undersigned offer to construct and complete the Works and remedy any defects therein for the sum of Kenya Shillings [Amount in figures].....

Kenya Shillings [amount in words].....

.....

The above amount includes foreign currency amount (s) of [state figure or a percentage and currency] [figures].....[words]

The percentage or amount quoted above does not include provisional sums, and only allows not more than two foreign currencies.

2. We undertake, if our tender is accepted, to commence the Works as soon as is reasonably possible after the receipt of the Engineer's notice to commence, and to complete the whole of the Works comprised in the Contract within the time stated in the Particular Conditions of Contract.
3. We agree to adhere by this tender until _____ *[Insert date]*, and it shall remain binding upon us and may be accepted at any time before that date.
4. Unless and until a formal Agreement is prepared and executed this tender together with your written acceptance thereof, shall constitute a binding Contract between us. We further understand that you are not bound to accept the lowest or any tender you may receive.
5. We, the undersigned, further declare that:
 - i) No reservations: We have examined and have no reservations to the tender document, including Addenda issued in accordance with ITT 8;
 - ii) Eligibility: We meet the eligibility requirements and have no conflict of interest in accordance with ITT 3 and 4;
 - iii) Tender-Securing Declaration: We have not been suspended nor declared ineligible by the Procuring Entity based on execution of a Tender-Securing or Proposal-Securing Declaration in the Procuring Entity's Country in accordance with ITT 19.8;
 - (iv) Conformity: We offer to execute in conformity with the tendering documents and in accordance with the implementation and completion specified in the construction schedule, the following Works: *[insert a brief description of the Works]*;
 - (v) Tender Price: The total price of our Tender, excluding any discounts offered in item 1 above is: *[Insert one of the options below as appropriate]*
 - (vi) **Option1**, in case of one lot: Total price is: *[insert the total price of the Tender in words and figures, indicating the various amounts and the respective currencies]*; Or
Option2, in case of multiple lots:
 - a) Total price of each lot *[insert the total price of each lot in words and figures, indicating the various amounts and the respective currencies]*; and
 - b) Total price of all lots (sum of all lots) *[insert the total price of all lots in words and figures, indicating the various amounts and the respective currencies]*;
 - vii) Discounts: The discounts offered and the methodology for their application are:
 - viii) The discounts offered are: *[Specify in detail each discount offered.]*

- ix) The exact method of calculations to determine the net price after application of discounts is shown below: [*Specify in detail the method that shall be used to apply the discounts*];
- x) Tender Validity Period: Our Tender shall be valid for the period specified in TDS 18.1 (as amended, if applicable) from the date fixed for the Tender submission deadline specified in TDS 22.1(as amended, if applicable), and it shall remain binding upon us and may be accepted at any time before the expiration of that period;
- xi) Performance Security: If our Tender is accepted, we commit to obtain a Performance Security in accordance with the Tendering document;
- xii) One Tender Per Tender: We are not submitting any other Tender(s) as an individual Tender, and we are not participating in any other Tender(s) as a Joint Venture member or as a subcontractor, and meet the requirements of ITT3.4, other than alternative Tenders submitted in accordance with ITT 13.3;
- xiii) Suspension and Debarment: We, along with any of our subcontractors, suppliers, Engineer, manufacturers, or service providers for any part of the contract, are not subject to, and not controlled by any entity or individual that is subject to, a temporary suspension or a debarment imposed by the Public Procurement Regulatory Authority or any other entity of the Government of Kenya, or any international organization.
- xiv) State-owned enterprise or institution: [*select the appropriate option and delete the other*] [*We are not a state- owned enterprise or institution*]/[*We are a state-owned enterprise or institution but meet the requirements of ITT 3.7*];
- xv) Commissions, gratuities, fees: We have paid, or will pay the following commissions, gratuities, or fees with respect to the tender process or execution of the Contract: [*insert complete name of each Recipient, its full address, the reason for which each commission or gratuity was paid and the amount and currency of each such commission or gratuity*]

Name of Recipient	Address	Reason	Amount

(If none has been paid or is to be paid, indicate “none.”)

- xvi) Binding Contract: We understand that this Tender, together with your written acceptance thereof included in your Letter of Acceptance, shall constitute a binding contract between us, until a formal contract is prepared and executed;
- xvii) Not Bound to Accept: We understand that you are not bound to accept the lowest evaluated cost Tender, the Most Advantageous Tender or any other. Tender that you may receive;
- xviii) Fraud and Corruption: We hereby certify that we have taken steps to ensure that no person acting for us or on our behalf engages in any type of Fraud and Corruption;
- xix) Collusive practices: We hereby certify and confirm that the tender is genuine, non-

collusive and made with the intention of accepting the contract if awarded. To this effect we have signed the “Certificate of Independent Tender Determination” attached below.

- xx) We undertake to adhere by the Code of Ethics for Persons Participating in Public Procurement and Asset Disposal, copy available from _____ (*specify website*) during the procurement process and the execution of any resulting contract.
- xxi) We, the Tenderer, have completed fully and signed the following Forms as part of our Tender:
 - a) Tenderer's Eligibility; Confidential Business Questionnaire – to establish we are not in any conflict to interest.
 - b) Certificate of Independent Tender Determination – to declare that we completed the tender without colluding with other tenderers.
 - c) Self-Declaration of the Tenderer– to declare that we will, if awarded a contract, not engage in any form of fraud and corruption.
 - d) Declaration and commitment to the Code of Ethics for Persons Participating in Public Procurement and Asset Disposal.

Further, we confirm that we have read and understood the full content and scope of fraud and corruption as informed in “**Appendix 1 – Fraud and Corruption**” attached to the Form of Tender.

Name of the Tenderer: (Insert complete name of person signing the Tender)

Name of the person duly authorized to sign the Tender on behalf of the Tenderer:

.....

****[insert complete name of person duly authorized to sign the Tender]**

Title of the person signing the Tender: [*insert complete title of the person signing the Tender*]

.....

Signature of the person named above: [*insert signature of person whose name and capacity are shown above*]

.....

Date signed [*insert date of signing*] day of [*insert month*], [*insert year*]

Date signed _____ day of _____, _____

Notes

** In the case of the Tender submitted by joint venture specify the name of the Joint Venture as Tenderer*

*** Person signing the Tender shall have the power of attorney given by the Tenderer to be attached with the Tender*

APPENDIX TO FORM OF BID

(This appendix forms part of the bid)

CONDITIONS OF CONTRACT	CLAUSE	AMOUNT
Law of contract		Laws of Kenya
Language and form of communication for the contract		English
Bid Security (Bank Guarantee or reputable insurance company approved by PPRA Only)		Kshs.51,000.00 from reputable bank or Insurance Company approved by PPRA
Amount of Performance Security (Unconditional Bank Guarantee)	10.1	5% of BID Sum in the form of Unconditional Bank Guarantee or cash retentions (Insurance bonds shall not be accepted)
Program to be submitted	14.1	Not later than 14 (Fourteen) days after issuance of Order to Commence
Cash flow estimate to be submitted	14.3	Not later than 14 (Fourteen) days after issuance of Order to Commence
Minimum amount of Third Party Insurance	23.2	0.3% of the contract value
Period for commencement, from Engineer's order to commence	41.1	14 days
Time for completion	43.1	3 (Three) months
Amount of liquidated damages	47.1	KShs. 5,000.00 per day
Limit of liquidated damages	47.1	10% of Contract Sum
Defects Liability period	49.1	6(Six) months
Percentage of Retention	60.3	10% of Interim Payment Certificate
Limit of Retention Money	60. 3	5% of Contract Sum
Minimum amount of interim payment certificates	60.2	Contract Sum
Time within which payment to be made after Interim Payment Certificate signed by Engineer	60.10	90 days
Time within which payment to be made after Final Payment Certificate signed by Engineer	60.10	90 days
Amount of Advance	60.12	NIL

Advance Payment Security	60.12	NIL
Appointer of Arbitrator/Adjudicator	67.3	The Chartered Institute of Arbitrators (Kenya)
Notice to Employer and Engineer	68.2	The Employer's address is: The County Secretary, County Government of Bungoma, P.O. Box 437 - 50200 BUNGOMA The Engineer's address is: The Chief Officer, Roads, Infrastructure and Public Works P.O. Box 437 - 50200 BUNGOMA
CONDITIONS OF CONTRACT	AMOUNT/DESCRIPTION	CONDITIONS OF CONTRACT CLAUSE
Approximate Weightings for Price Adjustment Formula	See Table A below	70.3
Weightings and Indices	Where necessary, in the table B below, bidders shall (a) indicate their amounts of local currency payment, (b) indicate their proposed source and base values of indices for the different foreign currency elements of cost, (c) derive their proposed weightings for local and foreign currency payment as indicated in table B below, and (d) list the exchange rates used in the currency conversion	70.3 , 70.4 and 70.5

Table A Approximate Weightings for Price Adjustment

<i>Description of Index</i>	<i>% Range of Weighting</i>
Fixed ("A")	8
Labour	8 – 12
Fuels and Lubricants	12 – 22
Equipment and Spares	35 – 40
Cement	8 – 12

Reinforcement and Steel products	1 – 3
Explosives	1 – 5
Bitumen and Bituminous products	15 – 25
Total	100

NOTE: ^a Denotes that this should be used as guidance to bidders and for purpose of checking their submissions, the Employer has estimated and provided a range of acceptable weightings for related major construction inputs in accordance with the potential range of construction methodologies, based on estimated cost in a common currency.

Table B: Bidder’s proposed weighting

<i>Index Code</i>	<i>Index Description</i>	<i>Source of Index</i>	<i>Base value and date</i>	<i>Bidder’s proposed weighting</i>
	Non adjustable	Civil Engineering Cost Indices from Kenya National Bureau of Statistics. For equipment & spares, the official indices from source country shall apply	The Indices prevailing at 28days before tender submission deadline shall apply	A: ____0.08__ b: ____ c: ____ d: ____ e: ____
			Total	1.00

Signature of Bidder.....Date

(Failure to sign this appendix will imply the bidder doesn’t accept the above conditions and hence disqualified)

TENDERER'S ELIGIBILITY-CONFIDENTIAL BUSINESS QUESTIONNAIRE

Instruction to Tenderer

Tender is instructed to complete the particulars required in this Form, *one form for each entity if Tender is a JV*. Tenderer is further reminded that it is an offence to give false information on this Form.

Tenderer's details

	ITEM	DESCRIPTION
1	Name of Procuring Entity	
2	Reference Number of the Tender	
3	Date and Time of Opening of the Tender	
4	Name of Tenderer	
5	Full address and Contact Details of the Tenderer	1) Country 2) City 3) Location 4) Building 5) Floor 6) Postal Address 7) Name and Email of contact Person
6	Current Trade License Registration Number and Expiring Date	
7	Name, Country and Full address (<i>postal and physical addresses, email and telephone number</i>) of Registering Body / Agency	
8	Description of Nature of Business	
9	Maximum value of business which Tenderer handles	
10	State if Tenders Company is listed in stock exchange, (<i>give</i>	

	<i>name and full address (postal and physical addresses, email and telephone number) of stock exchange</i>	
--	---	--

General and Specific Details

Sole Proprietor, provide the following details.

Name in full _____ Age _____

Nationality _____ Country of Origin _____

Citizenship _____

Partnership, provide the following details.

	Name of Partners	Nationality	Citizenship	% shares owned
1				
2				
3				
4				

Registered Company, provide the following details.

i) Private or public Company _____

ii) State the nominal and issued capital of the Company

Nominal Kenya Shillings (Equivalent).....

Issued Kenya Shillings (Equivalent).....

iii) Give details of Directors as follows.

	Name of Partners	Nationality	Citizenship	% shares owned
1				
2				
3				

DISCLOSURE OF INTEREST- Interest of the Firm in the Procuring Entity.

Are there any person/persons in..... (Name of Procuring Entity) who has/have an interest or relationship in this firm? Yes/No.....

If yes, provide details as follows.

	Name of Person	Designation in the Procuring Entity	Interest or relationship with Tenderer

Conflict of Interest disclosure

	Type of Conflict	Disclosure YES or NO	If YES, provide details of relationship with Tenderer
1	Tenderer is directly or indirectly controls, is controlled by or is under common control with another contractor		
2	Tenderer receives or has received any direct or indirect subsidy from another tenderer		
3	Tenderer receives or has received any direct or indirect subsidy from another tenderer		
4	Tender has a relationship with another tenderer, directly or through common third parties, that puts it in a position to influence the tender of another tenderer, or influence the decisions of the Procuring Entity regarding this tendering process.		
5	Any of the Tenderer's affiliates participated as a consultant in the preparation of the design or technical specifications of the works that are the subject of the tender.		
6	Tenderer would be providing goods, works, non-consulting services or consulting services during implementation of the contract specified in this Tender Document.		
7	Tenderer has a close business or family relationship with a professional staff of the Procuring		

	Entity who are directly or indirectly involved in the preparation of the Tender document or specifications of the Contract, and/or the Tender evaluation process of such contract.		
8	Tenderer has a close business or family relationship with a professional staff of the Procuring Entity who would be involved in the implementation or supervision of the such Contract.		
9	Has the conflict stemming from such relationship stated in item 7 and 8 above been resolved in a manner acceptable to the Procuring Entity throughout the tendering process and execution of the Contract		

Certification

On behalf of the Tenderer, I certify that the information given above is complete, current and accurate as at the date of submission.

Full Name _____ Title or Designation.....

(Signature)

(Date)

A. CERTIFICATE OF INDEPENDENT TENDER DETERMINATION

I, the undersigned, in submitting the accompanying Letter of Tender to the.....[Name of Procuring Entity] for:[Name and number of tender] in response to the request for tenders made by:[Name of Tenderer] do hereby make the following statements that I certify to be true and complete in every respect:

I certify, on behalf of.....[Name of Tenderer] that:

1. I have read and I understand the contents of this Certificate;
2. I understand that the Tender will be disqualified if this Certificate is found not to be true and complete in every respect;
3. I am the authorized representative of the Tenderer with authority to sign this Certificate, and to submit the Tender on behalf of the Tenderer;
4. For the purposes of this Certificate and the Tender, I understand that the word “competitor” shall include any individual or organization, other than the Tenderer, whether or not affiliated with the Tenderer, who:
 - a) has been requested to submit a Tender in response to this request for tenders;
 - b) could potentially submit a tender in response to this request for tenders, based on their qualifications, abilities or experience;
5. The Tenderer discloses that [check one of the following, as applicable]:
 - a) The Tenderer has arrived at the Tender independently from, and without consultation, communication, agreement or arrangement with, any competitor;
 - b) The Tenderer has entered into consultations, communications, agreements or arrangements with one or more competitors regarding this request for tenders, and
 - c) The Tenderer discloses, in the attached document(s), complete details thereof, including the names of the competitors and the nature of, and reasons for, such consultations, communications, agreements or arrangements;
6. In particular, without limiting the generality of paragraphs (5) (a) or (5) (b) above, there has

been no consultation, communication, agreement or arrangement with any competitor regarding:

- a. prices;
 - b. methods, factors or formulas used to calculate prices;
 - c. the intention or decision to submit, or not to submit, a tender; or
 - d. the submission of a tender which does not meet the specifications of the request for Tenders; except as specifically disclosed pursuant to paragraph (5) (b) above;
7. In addition, there has been no consultation, communication, agreement or arrangement with any competitor regarding the quality, quantity, specifications or delivery particulars of the works or services to which this request for tenders relates, except as specifically authorized by the procuring authority or as specifically disclosed pursuant to paragraph (5) (b) above;
8. The terms of the Tender have not been, and will not be, knowingly disclosed by the Tenderer, directly or indirectly, to any competitor, prior to the date and time of the official tender opening, or of the awarding of the Contract, whichever comes first, unless otherwise required by law or as specifically disclosed pursuant to paragraph (5) (b) above.

Name.....Title.....Date.....

FORM SD2

SELF DECLARATION THAT THE TENDERER WILL NOT ENGAGE IN ANY CORRUPT OR FRAUDULENT PRACTICE

I, of P. O. Box being a resident of..... in the Republic of..... do hereby make a statement as follows: -

1. THAT I am the Chief Executive/Managing Director/Principal Officer/Director of (*insert name of the Company*) who is a Bidder in respect of Tender No..... for (*insert tender title/description*) for (*insert name of the Procuring entity*) and duly authorized and competent to make this statement.
2. THAT the aforesaid Bidder, its servants and/or agents /subcontractors will not engage in any corrupt or fraudulent practice and has not been requested to pay any inducement to any member of the Board, Management, Staff and/or employees and/or agents of..... (*insert name of the Procuring entity*) which is the procuring entity.
3. THAT the aforesaid Bidder, its servants and/or agents /subcontractors have not offered any inducement to any member of the Board, Management, Staff and/or employees and/or agents of..... (*name of the procuring entity*)
4. THAT the aforesaid Bidder will not engage/has not engaged in any corrosive practice with other bidders participating in the subject tender
5. THAT what is deponed to herein above is true to the best of my knowledge, information and belief.

.....(Title) (Signature)
(Date)

Bidder's Official Stamp

DECLARATION AND COMMITMENT TO THE CODE OF ETHICS

I (person) on behalf of (*Name of the Business/Company/Firm*)declare that I have read and fully understood the contents of the Public Procurement & Asset Disposal Act, 2015, Regulations and the Code of Ethics for persons participating in Public Procurement and Asset Disposal and my responsibilities under the Code.

I do hereby commit to abide by the provisions of the Code of Ethics for persons participating in Public Procurement and Asset Disposal.

Name of Authorized signatory.....

Sign.....

Position.....

Office address..... Telephone.....

E-mail.....

Name of the Firm/Company.....

Date.....

(Company Seal/Rubber Stamp
where applicable) Witness

Name.....

Sign.....

Date.....

APPENDIX 1-FRAUD AND CORRUPTION

(Appendix 1 shall not be modified)

1.0 Purpose

- 1.1 The Government of Kenya's Anti-Corruption and Economic Crime laws and their sanction's policies and procedures, Public Procurement and Asset Disposal Act (*no. 33 of 2015*) and its Regulation, and any other Kenya's Acts or Regulations related to Fraud and Corruption, and similar offences, shall apply with respect to Public Procurement Processes and Contracts that are governed by the laws of Kenya.

2.0 Requirements

- 2.1 The Government of Kenya requires that all parties including Procuring Entities, Tenderers, (applicants/proposers), Consultants, Contractors and Suppliers; any Sub-contractors, Sub-consultants, Service providers or Suppliers; any Agents (whether declared or not); and any of their Personnel, involved and engaged in procurement under Kenya's Laws and Regulation, observe the highest standard of ethics during the procurement process, selection and contract execution of all contracts, and refrain from Fraud and Corruption and fully comply with Kenya's laws and Regulations as per paragraphs 1.1 above.
- 2.2 Kenya's public procurement and asset disposal act (*no. 33 of 2015*) under Section 66 describes rules to be followed and actions to be taken in dealing with Corrupt, Coercive, Obstructive, Collusive or Fraudulent practices, and Conflicts of Interest in procurement including consequences for offences committed. A few of the provisions noted below highlight Kenya's policy of no tolerance for such practices and behavior:
- 1) a person to whom this Act applies shall not be involved in any corrupt, coercive, obstructive, collusive or fraudulent practice; or conflicts of interest in any procurement or asset disposal proceeding;
 - 2) A person referred to under subsection (1) who contravenes the provisions of that subsection commits an offence;
 - 3) Without limiting the generality of the subsection (1) and (2), the person shall be—
 - a) disqualified from entering into a contract for a procurement or asset disposal proceeding; or
 - b) if a contract has already been entered into with the person, the contract shall be voidable;
 - 4) The voiding of a contract by the procuring entity under subsection (7) does not limit any legal remedy the procuring entity may have;
 - 5) An employee or agent of the procuring entity or a member of the Board or committee of the procuring entity who has a conflict of interest with respect to a procurement—
 - a) shall not take part in the procurement proceedings;
 - b) shall not, after a procurement contract has been entered into, take part in any

- decision relating to the procurement or contract; and
- c) shall not be a subcontractor for the bidder to whom was awarded contract, or a member of the group of bidders to whom the contract was awarded, but the subcontractor appointed shall meet all the requirements of this Act.
 - 6) An employee, agent or member described in subsection (1) who refrains from doing anything prohibited under that subsection, but for that subsection, would have been within his or her duties shall disclose the conflict of interest to the procuring entity;
 - 7) If a person contravenes subsection (1) with respect to a conflict of interest described in subsection (5) (a) and the contract is awarded to the person or his relative or to another person in whom one of them had a direct or indirect pecuniary interest, the contract shall be terminated and all costs incurred by the public entity shall be made good by the awarding officer. Etc.

2.3 In compliance with Kenya's laws, regulations and policies mentioned above, the Procuring Entity:

- a) Defines broadly, for the purposes of the above provisions, the terms set forth below as follows:
 - i) "corrupt practice" is the offering, giving, receiving, or soliciting, directly or indirectly, of anything of value to influence improperly the actions of another party;
 - ii) "fraudulent practice" is any act or omission, including misrepresentation, that knowingly or recklessly misleads, or attempts to mislead, a party to obtain financial or other benefit or to avoid an obligation;
 - iii) "collusive practice" is an arrangement between two or more parties designed to achieve an improper purpose, including to influence improperly the actions of another party;
 - iv) "coercive practice" is impairing or harming, or threatening to impair or harm, directly or indirectly, any party or the property of the party to influence improperly the actions of a party;
 - v) "obstructive practice" is:
 - deliberately destroying, falsifying, altering, or concealing of evidence material to the investigation or making false statements to investigators in order to materially impede investigation by Public Procurement Regulatory Authority (PPRA) or any other appropriate authority appointed by Government of Kenya into allegations of a corrupt, fraudulent, coercive, or collusive practice; and/or threatening, harassing, or intimidating any party to prevent it from disclosing its knowledge of matters relevant to the investigation or from pursuing the investigation; or
 - acts intended to materially impede the exercise of the PPRA's or the appointed authority's inspection and audit rights provided for under paragraph 2.3 e. below.
- b) Defines more specifically, in accordance with the above procurement Act provisions set forth for fraudulent and collusive practices as follows:

"fraudulent practice" includes a misrepresentation of fact in order to influence a

procurement or disposal process or the exercise of a contract to the detriment of the procuring entity or the tenderer or the contractor, and includes collusive practices amongst tenderers prior to or after tender submission designed to establish tender prices at artificial non-competitive levels and to deprive the procuring entity of the benefits of free and open competition.

- c) Rejects a proposal for award¹ of a contract if PPRA determines that the firm or individual recommended for award, any of its personnel, or its agents, or its sub-consultants, sub-contractors, service providers, suppliers and/ or their employees, has, directly or indirectly, engaged in corrupt, fraudulent, collusive, coercive, or obstructive practices in competing for the contract in question;
- d) Pursuant to the Kenya's above stated Acts and Regulations, may sanction or recommend to appropriate authority(ies) for sanctioning and debarment of a firm or individual, as applicable under the Acts and Regulations;
- e) Requires that a clause be included in Tender documents and Request for Proposal documents requiring (i) Tenderers (applicants/proposers), Consultants, Contractors, and Suppliers, and their Sub-contractors, Sub- consultants, Service providers, Suppliers, Agents personnel, permit the PPRA or any other appropriate authority appointed by Government of Kenya to inspect² all accounts, records and other documents relating to the procurement process, selection and/or contract execution, and to have them audited by auditors appointed by the PPRA or any other appropriate authority appointed by Government of Kenya; and
- f) Pursuant to Section 62 of the above Act, requires Applicants/Tenderers to submit along with their Applications/Tenders/Proposals a “Self-Declaration Form” as included in the procurement document declaring that they and all parties involved in the procurement process and contract execution have not engaged/will not engage in any corrupt or fraudulent practices.

For the avoidance of doubt, a party's ineligibility to be awarded a contract shall include, without limitation, (i) applying for pre-qualification, expressing interest in a consultancy, and tendering, either directly or as a nominated sub-contractor, nominated consultant, nominated manufacturer or supplier, or nominated service provider, in respect of such contract, and (ii) entering into an addendum or amendment introducing a material modification to any existing contract.

² Inspections in this context usually are investigative (i.e., forensic) in nature. They involve fact-finding activities undertaken by the Investigating Authority or persons appointed by the Procuring Entity to address specific matters related to investigations/audits, such as evaluating the veracity of an allegation of possible Fraud and Corruption, through the appropriate mechanisms. Such activity includes but is not limited to: accessing and examining a firm's or individual's financial records and information, and making copies thereof as relevant; accessing and examining any other documents, data and information (whether in hard copy or electronic format) deemed relevant for the investigation/audit, and making copies thereof as relevant; interviewing staff and other relevant individuals; performing physical inspections and site visits; and obtaining third party verification of information

FORM CON – 3(A): DECLARATION OF KNOWLEDGE OF SITE

This is to certify that

[Name/s].....
.....

Being the authorized representative/Agent of [Name of bidder]

.....
.....
.....

Has familiarized himself/herself with the Site conditions in accordance with the Instructions to bidders and the Tender Notice for purposes of bidding for this road project

Having studied the tender Documents, and gained knowledge of local conditions on site likely to influence the works and cost thereof, I certify that I am satisfied with the description of the works and understand the scope of works as specified and as implied in this tender.

.....
.....
..... (Signed and Stamped by Authorized Bidder’s Agent/
Representative) (Designation)

FORM CON – 3(B): CERTIFICATE OF BIDDER’S VISIT TO SITE (NOT MANDATORY)

This is to certify that

.....
(Name of Tenderer’s Representative) (Designation)

Being the authorized representative/Agent of [*Name of bidder*]
.....

Participated in the organized inspection visit of the site of the works for the



Held on.....day of.....20.....

Signed.....
(Employer’s Representative)

.....
.....

.....
(Name of Employer’s Representative) (Designation)

NOTE: This form is to be completed at the time of the organized site visit.

FORM OF TENDER SECURITY - DEMAND BANK GUARANTEE

Beneficiary: _____

Request for Tenders No: _____

Date: _____

TENDER GUARANTEE No.: _____

Guarantor: _____

1. We have been informed that _____(herein after called "the Applicant") has submitted or will submit to the Beneficiary its Tender (herein after called "the Tender") for the execution of _____under Request for Tenders No. _____("the ITT").
2. Furthermore, we understand that, according to the Beneficiary's conditions, Tenders must be supported by a Tender guarantee.
3. At the request of the Applicant, we, as Guarantor, hereby irrevocably undertake to pay the Beneficiary any sum or sums not exceeding in total an amount of _____(_____) upon receipt by us of the Beneficiary's complying demand, supported by the Beneficiary's statement, whether in the demand itself or a separate signed document accompanying or identifying the demand, stating that either the Applicant:
 - a) Has withdrawn its Tender during the period of Tender validity set forth in the Applicant's Letter of Tender ("the Tender Validity Period"), or any extension there to provided by the Applicant; or
 - b) Having been notified of the acceptance of its Tender by the Beneficiary during the Tender Validity Period or any extension thereto provided by the Applicant, (i) has failed to execute the contract agreement, or (ii) has failed to furnish the Performance.
4. This guarantee will expire: (a) if the Applicant is the successful Tenderer, upon our receipt of copies of the contract agreement signed by the Applicant and the Performance Security and, or (b) if the Applicant is not the successful Tenderer, upon the earlier of (i) our receipt of a copy of the Beneficiary's notification to the Applicant of the results of the Tendering process; or(ii)twenty-eight days after the end of the Tender Validity Period.
5. Consequently, any demand for payment under this guarantee must be received by us at the office indicated above on or before that date.

[signature(s)]

3.0 FORM OF TENDER SECURITY (TENDER BOND)

[The Surety shall fill in this Tender Bond Form in accordance with the instructions indicated.] BOND NO. ____

1. BY THIS BOND *[name of tenderer]* as Principal (herein after called “the Principal”), and *[name, legal title, and address of surety]*, **authorized to transact business in *[name of country of Purchaser]***, as Surety (herein after called “the Surety”), are held and firmly bound unto *[name of Purchaser]* as Obligee (herein after called “the Purchaser”) in the sum of *[amount of Bond]*⁵*[amount in words]*, for the payment of which sum, well and truly to be made, we, the said Principal and Surety, bind ourselves, our successors and assigns, jointly and severally, firmly by these presents.

2. WHERE AS the Principal has submitted or will submit a written Tender to the Purchaser dated the.....Day of....., , for the supply of *[name of Contract]* (herein after called the “Tender”).

3. NOW, THEREFORE, THE CONDITION OF THIS OBLIGATION is such that if the Principal:
 - a) Has withdrawn its Tender during the period of Tender validity set forth in the Principal's Letter of Tender (“the Tender Validity Period”), or any extension thereto provided by the Principal; or

 - b) having been notified of the acceptance of its Tender by the Purchaser during the Tender Validity Period or any extension thereto provided by the Principal; (i) failed to execute the Contract agreement; or (ii) has failed to furnish the Performance Security, in accordance with the Instructions to tenderers (“ITT”) of the Purchaser's Tendering document.

Then the Surety undertakes to immediately pay to the Purchaser up to the above amount upon receipt of the Purchaser's first written demand, without the Purchaser having to substantiate its demand, provided that in its demand the Purchaser shall state

that the demand arises from the occurrence of any of the above events, specifying which event(s) has occurred.

- 4. The Surety hereby agrees that its obligation will remain in full force and effect upto and including the date 30 days after the date of expiration of the Tender Validity Period set forth in the Principal's Letter of Tender or any extension thereto provided by the Principal.
- 5. IN TESTIMONY WHEREOF, the Principal and the Surety have caused these presents to be executed in their respective names this day of

PRINCIPAL.....SURETY.....
Corporate Seal (where appropriate)
Signature.....Signature.....

(Printed Name and Title)

(Printed Name and Title)

⁵The amount of the Bond shall be denominated in the currency Kenya shillings or the equivalent amount in a freely convertible currency.

4.0 FORM OF TENDER-SECURING DECLARATION

[The Bidder shall complete this Form in accordance with the instructions indicated]

Date: [insert date (as day, month and year) of Tender Submission]

Tender No.: [insert number of tendering process]

To..... [insert complete name of Purchaser]

I/We, the undersigned, declare that:

1. I/We understand that, according to your conditions, bids must be supported by a Tender-Securing Declaration.
2. I/We accept that I/we will automatically be suspended from being eligible for tendering in any contract with the Purchaser for the period of time of [insert number of months or years] starting on [insert date], if we are in breach of our obligation(s) under the bid conditions, because we—(a) have withdrawn our tender during the period of tender validity specified by us in the Tendering Data Sheet; or (b) having been notified of the acceptance of our Bid by the Purchaser during the period of bid validity, (i) fail or refuse to execute the Contract, if required, or (ii) fail or refuse to furnish the Performance Security, in accordance with the instructions to tenders.
3. I/We understand that this Tender Securing Declaration shall expire if we are not the successful Tenderer(s), upon the earlier of:
 - a) our receipt of a copy of your notification of the name of the successful Tenderer; or
 - b) thirty days after the expiration of our Tender.
4. I/We understand that if I am/we are/in a Joint Venture, the Tender Securing Declaration must be in the name of the Joint Venture that submits the bid, and the Joint Venture has not been legally constituted at the time of bidding, the Tender Securing Declaration shall be in the names of all future partners as named in the letter of intent.

SignedCapacity /Title (Director, Partner or Sole proprietor)

Name:.....

Duly authorized to sign the bid for and on behalf of:

.....(Insert Complete Name of Tenderer)

Dated on This Dayof (Insert date of signing and seal or stamp)

5.0 APPENDIX TO TENDER

Schedule of Currency requirements

Summary of currencies of the Tender for

(Insert name of section of the works)

Name of Currency	Amounts Payable
Local Currency.....	
Foreign Currency # 1:.....	
Foreign Currency # 1:.....	
Foreign Currency # 1:.....	
Provisional sums expressed in local currency	(To be entered by the procuring entity)

6.0 TECHNICAL PROPOSAL

The tender shall complete these sections as a Technical proposal to indicate how he/she intends to proceed with the works. The Procuring entity will review these Proposals and determine the extent to which they meet the required standards to complete the works.

6.1 Site Organization

[insert Site Organization information]

6.2 Method Statement

[insert Method Statement]

6.3 Mobilization Schedule

[insert Mobilization Schedule]

6.4 Construction Schedule

[insert Construction Schedule]

PART 2: WORK REQUIREMENTS

SECTION VI : BILLS OF QUANTITIES

PREAMBLE TO BILL OF QUANTITIES

1. The Bills of Quantities forms part of the Contract Documents and are to be read in conjunction with the Instructions to Bidders, Conditions of Contract Parts I and II, Specifications and Drawings.
2. The brief description of the items in the Bills of Quantities is purely for the purpose of identification, and in no way modifies or supersedes the detailed descriptions given in the Conditions of Contract and Specifications for the full direction and description of work and materials.
3. The Quantities set forth in the Bills of Quantities are estimated, representing substantially the work to be carried out, and are given to provide a common basis for bidding and comparing of Bids. There is no guarantee to the Contractor that he will be required to carry out all the quantities of work indicated under any one particular item or group of items in the Bill of Quantities. The basis of payment shall be the Contractor's rates and the quantities of work actually done in fulfilment of his obligation under the Contract.
4. The prices and rates inserted in the Bills of Quantities will be used for valuing the work executed, and the Engineer will only measure the whole of the works executed in accordance with this Contract.
5. A price or rate shall be entered in ink against every item in the Bills of Quantities with the exception of items that already have Provisional sums affixed thereto. The bidders are reminded that no “nil” or “included” rates or “lump-sum” discounts will be accepted. The rates for various items should include discounts if any. Bidders who fail to comply will be disqualified.
6. Provisional sums (including Day works) in the Bills of Quantities shall be expended in whole or in part at the discretion of the Engineer in accordance with Sub-Clause 52.4 and Clause 58 of Part I of the Conditions of Contract.
7. The price and rates entered in the Bills of Quantities shall, except insofar as it is otherwise provided under the Contract, include all Constructional plant to be used, labour, insurance, supervision, compliance testing, materials, erection, maintenance of works, overheads and profits, taxes and duties (excluding VAT) together with all general risks, liabilities and obligations set out or implied in the Contract, transport, electricity and telephones, water, use and replenishment of all consumables, including those required under the contract by the Engineer and his staff.
8. Errors in the pricing of the Bills of Quantities will be corrected in accordance with Clause 29 of instructions to bidders.

9. The whole cost of complying with the provisions of the Contract shall be included in the Items provided in the priced Bill of Quantities, and where no Items are provided, the cost shall be deemed to be distributed among the rates and prices entered for the related Items of Work.
10. General directions and descriptions of work and materials are not necessarily repeated or summarized in the Bill of Quantities. References to the relevant sections of the Contract documentation shall be made before entering prices against each item in the priced Bill of Quantities.
11. The method of measurement of completed work for payment shall be in accordance with *Standard Specification for Road and Bridge Construction* of the Ministry of Transport and Communications, 1986.
12. "Authorised" "Directed" or "Approved" shall mean the authority, direction or approval of the Engineer.
13. Unless otherwise stated, all measurements shall be net taken on the finished work carried out in accordance with the details shown on the drawings or instructed, with no allowance for extra cuts or fills, waste or additional thickness necessary to obtain the minimum finished thickness or dimensions required in this contract. Any work performed in excess of the requirements of the plans and specifications will not be paid for, unless ordered in writing by the Engineer.
14. Units of Measurement and abbreviations used herein shall have the following meanings:

Unit	Abbreviation	Unit	Abbreviation
cubic meter	m ³ or cu m	millimeter	mm
hectare	ha	month	mth
hour	hr	number	No.
kilogram	kg	provisional sum	P.S.
kilometre	km	square meter	m ² or sq m
lump sum	L.S.	square millimeter	mm ² or sq mm
meter	m	vehicle	veh
metric ton (1,000 kg)	t	week	wk
	mths		

ROAD NAME: PERIODIC MAINTENANCE OF ROADS IN NAMWELA WARD

Bill No. 1	Item Code	Description	QTY	Unit	Rate	Total Cost
1	01-50-003	Survey Works	1	PC SUM	50,000.00	50,000.00
	01-80-010	Allow a prime cost of sum for material testing as directed by the Engineer	1.00	PC SUM	100,000.00	100,000.00
	01-80-011	Extra over item 01-80-010 or contractors overheads and profits	100,000.00			
	01-80-017	Provide and erect publicity signs as directed by the Engineer	3	No.		
	01-80-030	Allow a prime cost for attendance to the RE,s supervisory staff including overtime	0	PC SUM	0	
	01-80-031	Include percentage of PC sum in item 01-80-030 for contractors overhead and profit				
TOTAL FOR BILL No.1 CARRIED TO THE MAIN SUMMARY PAGE						
PERIODIC MAINTENANCE OF SENGETETI-WANGWE-KOLANI ROAD 2.5 KM						
BILL No.10: GRADING AND GRAVELLING WORKS						
10	10.50.00 2	Grading of Carriageway including slopes and ditches as instructed by the engineer	22500	M ²		
	10.60.00 1	Provide gravel wearing course excavation, free haul, spread, water and compact gravel to specifications as directed by the engineer	1000	M ³		
	TOTAL FOR BILL No.10 CARRIED TO THE SUMMARY PAGE					
BILL No. 22 DAYWORKS						
22	22-50-001	DOZER D6 OR Equivalent	0	EH		
TOTAL FOR BILL No.22 CARRIED TO THE SUMMARY PAGE						

SUMMARY PAGE		
Bill No.	Item Description	Amount
8	Culverts and Drainage Structures	
10	Grading and Gravelling Works	
22	Dayworks	
	SUB TOTAL CARRIED TO SUMMARY PAGE	

Signed and Stamped:.....Date:.....

ROAD NAME: PERIODIC MAINTENANCE OF CHWELE GIRLS-SIBUMBA-KWAFU ROAD 7.2 KM

BILL No.7: EXCAVATION AND FILLING FOR STRUCTURES

Bill No. 1	Item Code	Description	QTY	Unit	Rate	Total Cost
7	07-60-002	Provide and place gabion boxes and mattresses as specified or as directed by the Engineer	40	M ³		
	07-60-003	Provide and place rock fill to gabions and mattresses	40	M ³		

TOTAL FOR BILL No.7 CARRIED TO THE SUMMARY PAGE

BILL No.8: CULVERT AND DRAINAGE WORKS

Bill No. 8	Item Code	Description	QTY	Unit	Rate	Total Cost
	08-60-025	Provide, lay and joint 600mm pipe culvert, concrete haunching and concrete headwalls, wingwalls, Toe and Aprons ensuring BRC in all concrete as instructed by the Engineer	24	M		
	08-60-027	Provide, lay and joint 900mm pipe culvert	14	M		
	08-90-002	Excavate for inlet, Outfall, Catch water drains, mire and cut off drains as directed by the Engineer.	100	M ³		

TOTAL FOR BILL No.8 CARRIED TO THE SUMMARY PAGE

BILL NO.10: GRADING AND GRAVELLING WORKS						
10	10.50.00 2	Grading of Carriageway including slopes and ditches as instructed by the engineer	64800	M ²		
	10.60.00 1	Provide gravel wearing course excavation, free haul, spread, water and compact gravel to specifications as directed by the engineer	1800	M ³		
TOTAL FOR BILL No.10 CARRIED TO THE SUMMARY PAGE						
BILL No. 22 DAYWORKS						
22	22-50-001	DOZER D6 OR Equivalent	30	EH		
TOTAL FOR BILL No.22 CARRIED TO THE SUMMARY PAGE						

SUMMARY PAGE		
Bill No.	Item Description	Amount
7	Excavation and Filling for structures	
8	Culverts and Drainage Works	
10	Grading and Graveling Works	
22	Day works	
	SUB TOTAL CARRIED TO SUMMARY PAGE	

Signed and Stamped:.....Date:.....

**ROAD NAME: PERIODIC MAINTENANCE OF CHWELE GIRLS-MUTONYI-
BUTUNDE ROAD 4.0 KM**

BILL No.7: EXCAVATION AND FILLING FOR STRUCTURES

Bill No. 1	Item Code	Description	QTY	Unit	Rate	Total Cost
7	07-60-002	Provide and place gabion boxes and mattresses as specified or as directed by the Engineer	40	M ³		
	07-60-003	Provide and place rock fill to gabions and mattresses	40	M ³		

TOTAL FOR BILL No.7 CARRIED TO THE SUMMARY PAGE

BILL No.8: CULVERT AND DRAINAGE WORKS

Bill No. 8	Item Code	Description	QTY	Unit	Rate	Total Cost
	08-60-025	Provide, lay and joint 600mm pipe culvert, concrete haunching and concrete headwalls, wingwalls, Toe and Aprons ensuring BRC in all concrete as instructed by the Engineer	16	M		
	08-60-027	Provide, lay and joint 900mm pipe culvert	0	M		
	08-90-002	Excavate for inlet, Outfall, Catch water drains, mire and cut off drains as directed by the Engineer.	0	M ³		

TOTAL FOR BILL No.8 CARRIED TO THE SUMMARY PAGE

BILL NO.10: GRADING AND GRAVELLING WORKS

10	10.50.00 2	Grading of Carriageway including slopes and ditches as instructed by the engineer	36000	M ²		
	10.60.00 1	Provide gravel wearing course excavation, free haul, spread, water and compact gravel to specifications as directed by the engineer	1500	M ³		

TOTAL FOR BILL No.10 CARRIED TO THE SUMMARY PAGE

BILL No. 22 DAYWORKS

22	22-50-001	DOZER D6 OR Equivalent	0	EH		
----	-----------	------------------------	---	----	--	--

TOTAL FOR BILL No.22 CARRIED TO THE SUMMARY PAGE

SUMMARY PAGE		
Bill No.	Item Description	Amount
7	Excavation and Filling for structures	
8	Culverts and Drainage Works	
10	Grading and Gravelling Works	
22	Day works	
	SUB TOTAL CARRIED TO SUMMARY PAGE	

Signed and Stamped:.....Date:.....

GRAND SUMMARY PAGE

NO.	ROAD NAME	AMOUNT
1	PRELIMINARIES AND GENERAL ITEMS	
2	PERIODIC MAINTENANCE OF SENGETETI-WANGWE-KOLANI ROAD	
3	PERIODIC MAINTENANCE OF CHWELE GIRLS-SIBUMBA-KWAFU ROAD	
4	PERIODIC MAINTENANCE OF CHWELE GIRLS-MUTONYI-BUTUNDE ROAD	
	SUB – TOTAL 1	
	ADD 0% CONTIGENCIES	
	SUB – TOTAL 2	
	ADD 16% VAT	
	GRAND TOTAL	

..... Date.....
 Signed and Stamped

SPECIFICATIONS

102 LOCATION OF CONTRACT

The Project is located in **Namwela Ward, Sirisia Sub County**.

103 EXTENT OF CONTRACT

The works to be executed under the contract shall comprise mainly but are not limited to the following:

- a) Preliminaries and General Items
- b) Site clearance and demolitions
- c) Installation of culverts
- d) Grading and Gravelling
- e) Any other activity not listed above but may be deemed necessary and instructed by the Engineer.
- f) Maintenance of the works during the construction period

104 PROGRAMME OF EXECUTION OF THE WORKS

The contractor shall provide the works programme, required under clause 8 of the Conditions of Contract, within 14 days of receipt of the Engineer's Order to commence work. The programme shall be co-ordinated with climatic and other conditions to provide for the completion of the works in the order and by the time specified.

The Contractor shall carry out the contract in accordance with the programme agreed with the Engineer, but he shall in no manner be relieved by the Engineer's approval of the programme, of his obligation to complete the works in the prescribed order and by the prescribed completion date and he shall from time to time review his progress and make such amendments to his rate of execution of the works as may be necessary to fulfil his obligations.

105 ORDER OF EXECUTION OF WORKS

In addition to Clause 105 of the Standard Specification the Contractor shall carry out the Works such that a continuous and consecutive output of fully completed work is achieved.

107 TAKING OVER CERTIFICATE

The minimum length of the road for which a certificate will be issued under clause 48 of the conditions of Contract shall be a whole length of the road substantially completed.

109 NOTICE OF OPERATIONS

Add the following sub- Clause. Notification Terms It shall be the Contractor's responsibility to notify the Engineer when any item of works scheduled are completed and ready for approval, and the contractor shall give sufficient notice to allow control test to be performed. Explosive and Blasting The requirements of the Laws of Kenya governing explosives and other requirements and regulations of Government of Kenya and other authorities shall be complied with. No explosives of any kind shall be used without prior written consent of the Engineer. The Contractor shall be solely responsible for the provision, handling, storage and transporting of all explosives, ancillary materials and all other items of related kind whatsoever required for blasting.

120 PROTECTION OF EXISTING WORKS AND SERVICES

The Contractor shall acquaint himself with the position of all existing services such as sewers, water drains, cables for electricity and telephone, lighting and telephone poles, water mains, etc., before commencing any excavation or other work likely to affect the existing services. The cost of all plant, equipment and materials, labour, technical and professional staff, transport and the like necessary for determining the locations of existing services, including the making good of any damage caused to such services all to the satisfaction of the Engineer, shall be deemed to be included in the tender rates. No other payment shall be made for the costs of such operations, nor for the making good of damage caused thereby to the existing services. The Contractor shall be held responsible for injury to existing structures, works or services and shall indemnify and keep

indemnified the Employer against any claims in this respect (including consequential damages).

124 LAND FOR ALL CAMPS SITES AND FOR THE CONTRACTOR'S OWN PURPOSES, INCLUDING TEMPORARY WORKS.

Notwithstanding Clause 124 of the Standard Specification all requirements of land for temporary works and construction purposes shall be to the approval of the Engineer but the Contractor will make all necessary arrangements with the property owners concerned and pay all charges arising therefrom. On or before completion of the Contract, the Contractor shall remove all temporary works and shall restore all such land to the condition in which it was immediately prior to the occupation thereof as far as is reasonable and practicable. No separate payment will be made to the Contractor on account of these items and the Contractor must make due allowance for them in his rates. Notwithstanding Clause 120 of the Standard Specifications, the Contractor shall be required to appoint competent surveyors who will liaise with the Engineer on matters related to the demarcation of the existing road reserve, site measurements, removal and reinstatement of existing services.

128 STORAGE OF MATERIALS

All materials shall be stored on Site in a manner approved by the Engineer and the Contractor shall carefully protect from the weather all work and materials which may be affected thereby.

129 TEST CERTIFICATES

When instructed by the Engineer the Contractor shall submit certificates of test from the suppliers of materials and goods required in connection with the works as the Engineer may require. Such certificates shall certify that the materials or goods concerned have been tested in accordance with the requirements of the specifications and shall give the results of all the tests carried out. The Contractor shall provide adequate means of identifying the materials and goods delivered to the site with the corresponding certificates.

131 SIGNBOARDS

The Contractor shall provide and erect two (2) publicity signs on the site as directed. The Engineer shall, as shown in the Drawings, direct the minimum dimensions and thickness of the steel framework and sheet. The framework and sheet shall be prepared and painted black, while the ring at the top of the supporting frames shall be painted white. The wordings and Bungoma County logo shall be printed on backlit sticker paper resistant to the effects of weather using reflectorized paint or material approved by the Engineer. The colours, fonts and heights of the letters shall be as indicated on the attached drawings and as directed by the Engineer.

Signboard shall be removed and transported to RD's Yard at the end of Defects Liability Period.

132.7 ENGINEER'S LABORATORY AND SURVEY EQUIPMENT

The Contractor shall provide Engineer's laboratory as shown in the Book of Drawings and provide all the laboratory equipment, reagents and survey equipment as required by the Engineer. The Contractor shall be paid under appropriate bill items in the Bills of Quantities or on provision of receipts as required by the Engineer.

The Contractor may be directed to pay for stationery, equipment or reagents that are foresaid and also pay for servicing and repair of the laboratory equipment being used on the project. The Contractor shall provide, install and maintain in a good state of repair, such laboratory, survey and other equipment as listed for the duration of the contract.

Such equipment shall be of approved manufacture, and shall be made available to the Engineer for the Engineer's exclusive use throughout the Contract, not later than three (3) weeks after the Engineer's order to supply. All equipment shall be ready to use and complete to perform the tests.

The equipment shall revert to the Employer on completion of the Contract Any delays to the Contractor or the Contractor's activities caused by the Engineer being unable to perform survey work, field or laboratory tests due to the Contractor's failure to supply and/or maintain the said equipment shall be deemed to have been caused entirely by the

Contractor's own actions, and any consequences of such delays shall be interpreted as such.

The payment to comply with this requirement is provided in the Bill of Quantities and ownership of all equipment shall revert to the Employer after the completion of the Works.

Failure by the Contractor to provide or maintain the equipment shall make him responsible to bear all costs that may be incurred as a result of the Engineer's staff using alternative means of communication, including delays in supervision and approval of Works by the Engineer. List of Laboratory and Survey Equipment shall revert to the Employer at the end of the Contract. The laboratory equipment shall be purpose-made for use in highways materials testing laboratories and shall comply with the relevant British (BS) or American (AASHTO) Standards.

Resident Engineer's Laboratory Furniture and Equipment

As listed in Appendix to Item 01-80-032 and 01-80-033 of the bills of quantities.

Resident Engineer's Survey Equipment

As listed in Appendix to Item 01-80-034 of the bills of quantities.

132.1 ENGINEER'S REPRESENTATIVE OFFICE

The Contractor may be instructed by the Engineer under clause 13.4 of the General Conditions of Contract to make payments of general receipted accounts for such items as stationery, stores, furniture and equipment, claims and allowances for supervision personnel and any miscellaneous claims or the Engineer may direct the Contractor to purchase or pay for the above. The Contractor will, on provision of receipts, be paid under appropriate bill items in the BoQ.

The Contractor, when instructed, shall provide and install at the Engineer's office the Equipment specified below with a dealer's certificate and warranty:

Three years' warranty

Satellite Phone Docking Station

Office docking adaptor that allows you to use Thuraya XT and XT-PRO satellite or equivalent phones indoors.

Easy to install and operate, the FDU-XT supports Voice, Data and Fax transmissions. It comes complete with satellite and GPS antennas with 25m cables to ensure seamless satellite connectivity.

Size 221 x 176 mm

Voice call External telephone connection,

Auxiliary handset connection Fax call

External G3 fax connection Power Universal AC/DC power supply: 110 – 240V; Input power DC 12V/24V/34V

115 FDU-XT Features:

High-quality voice transmissions: Supports high-quality voice transmissions via an auxiliary handset, speakerphone or any analog extension telephone Multi-functional: The FDU-XT charges the satellite phone while docked in the cradle GmPRS services: Supports GmPRS services with a USB port or DTE Circuit switched data: Supports circuit switched data service at speeds of up to 9.6 kbps Fax services: Supports selected Group3 analog fax machines and PC fax at speeds of up to 9.6 kbps PABX connection: Supports PABX connection

132.3 COMMUNICATION FOR THE ENGINEER

Internet and e-mail services Where directed, the contractor shall provide 24 hours' terrestrial or wireless internet connectivity with minimum throughput speed of 128kilobytes per second for the exclusive use by the Engineer, including all accessories and Terminal Equipment and pay for all associated installation, maintenance and usage charges throughout the duration of the contract. The contractor shall allow for the

provision and maintenance of internet connectivity and associated costs as per Appendix to item 01-80-026 of the Bills of Quantities.

137 ATTENDANCE UPON THE ENGINEER AND HIS STAFF

The costs, for attendance required by this Clause 137, shall be as specified in the attached table: -

Designation	Number
Resident Engineer	1
Assistant Resident Engineer	1
Materials Engineer	1
Surveyor	1
Senior Inspector	1
Senior Lab. Technologist	1
Inspectors	4
Lab Technician	3
CAD Technician	1
Chain Men	2
Leveller	1

and shall be paid for under Item 01-80-030A of the Bill of Quantities. In addition to the above listed staff, the Employer will attach under training or internship/Industrial attachment additional number of technical staff comprising Engineers, Inspectors, Surveyors and Materials Technologists. These staff shall be paid a stipend as shall be directed by the Engineer and the Contractor shall be reimbursed under Item 01-50-002 of the Bill of Quantities.

**138 VEHICLES AND DRIVERS FOR THE ENGINEER AND HIS STAFF AND
METHOD OF PAYMENT**

In addition to provisions of the Clause 138 of the Standard Specification, the Contractor shall when have instructed to do so provide, fuel and maintain in good working

conditions, with driver, the number and type of vehicle specified in the Bill of Quantities for exclusive use of the Engineer and his staff throughout the Contract.

The Contractor shall insure comprehensively the vehicles for any licensed driver and shall provide competent drivers during normal working hours and whenever required by the Engineer. Should any vehicle supplied not be in road worthy condition, the Contractor shall provide equivalent replacement vehicle until such time as the original vehicle is repaired to the satisfaction of the Engineer and returned for use.

Payment for the vehicles up to 5,000Km shall be by months. Payment for mileage above 5,000Km shall be made at a rate per kilometer.

The payment shall be inclusive of all fuels, lubricants, servicing, insurance, maintenance, drivers and repairs. The rate shall include any overtime the driver might be due or any other allowance to the normal working hours. Payment shall be made under relevant items in Bills of Quantities No. 1. The vehicles provided under this clause shall revert to the Employer.

139 MISCELLANEOUS ACCOUNTS

The Contractor maybe instructed by the Engineer to make payments of general miscellaneous accounts for such items as stationary, stores and equipment and miscellaneous supervision personnel and claims or the Engineer may direct the Contractor to purchase or pay for the above. The Contractor will be paid on a prime cost basis plus a percentage for overheads and profits under appropriate items in the Bills of Quantities.

140 PAYMENT OF OVERTIME FOR ENGINEER'S JUNIOR STAFF

If the Contractor wishes to execute permanent work outside the Engineer's normal working hours, as stated in Clause 108 of this Specification, then the payment for the overtime for Engineer's support staff shall be paid by the Contractor, at the latest Ministry of Labour rate.

142 ENVIRONMENTAL PROTECTION

The Contractor shall comply with the Statutory Regulations in force in Kenya regarding environmental protection and waste disposal, and shall liaise with the National Environmental Management Agency (NEMA). Within four (4) weeks of the order to commence work, the Contractor shall prepare and submit a specific Environmental Management Plan for the project and his operations, relating to the approved Environmental Impact Assessment.

The Environmental Management Plan shall outline potential environmental hazards and risks, and provide an action plan to deal with the hazards, minimise the risks, and mitigate adverse environmental impacts, and include a general decommissioning plan covering all relevant aspects of the project. The Environmental Management Plan shall identify monitoring indicators and reporting requirements.

The Contractor shall be required to submit environmental progress reports to the Engineer every three (3) months.

The Contractor shall ensure so far as is reasonably practicable and to the satisfaction of the Engineer; that the impact of the construction on the environment shall be kept to a minimum and that appropriate measures are taken to mitigate any adverse effects during the construction.

- (a) The Contractor shall exercise care to preserve the natural landscape and shall conduct his construction operations so as to prevent any unnecessary destruction, scarring, or defacing of the natural surroundings in the vicinity of the work. Except where clearing is required for permanent works, all trees, native shrubbery, and vegetation shall be preserved and shall be protected from damage by the Contractor's construction operations and equipment. All unnecessary destruction, scarring, damage or defacing resulting from the Contractor's operations shall be repaired, replanted, reseeded or otherwise corrected as directed by the Engineer, and at the Contractor's expense.
- (b) The Contractor shall ensure that measures are in place to control soil erosion and water pollution, by use of berms, dykes, silt fences, brush barriers, dams,

sediment basins, filter mats, netting, gravel, mulches, grasses, slope drains, contour banks, and other erosion control devices and methods. Temporary erosion control provisions shall be coordinated with permanent erosion control features to assure economical, effective and continuous measures throughout the period of the works. The Contractor's attention is drawn to the requirements of Clause 502, in that works need to be progressively finished so that permanent vegetation can establish quickly to mitigate soil erosion and erosion of drains.

- (c) The Contractor shall provide all the labour, equipment, materials, and means required and shall carry out proper and efficient measures wherever and as often as necessary to minimise the dust nuisance.
- (d) The Contractor shall comply with all applicable Kenyan laws, orders and regulations concerning the prevention, control and abatement of excessive noise. Blasting, use of jackhammers, pile driving, rock crushing, or any other activities producing high-intensity impact noise may be performed at night only upon approval of the Engineer.
- (e) Immediately after extraction of materials, all borrows pits shall be backfilled to the satisfaction of the Engineer. In particular, borrow pits near the project road shall be backfilled in such a way that no water collects in them.
- (f) Spilling of bitumen fuels Oils and other pollutants shall be cleared up.
- (g) The Contractor's attention is drawn to the requirements of the Standard Specification in regard to the environment and in particular to the following clauses:
 - Clause 115: Construction Generally
 - Clause 116: Protection from Water
 - Clause 136: Removal of Camps
 - Clause 605: Safety and Public Health Requirements
 - Clause 607: Site Clearance and Removal of Topsoil and Overburden
- (h) Payment in respect of this Clause 142 is included as a Lump Sum in the Bill of Quantities. Payment of the Lump Sum will be by equal monthly instalments over the period of the Contract excluding the Period of Maintenance. The total sum of

the instalments shall not exceed the Lump Sum, and payment of the monthly instalment will only be made for that month if the Engineer is satisfied that the Contractor has fully complied with the requirements of Clause 142, otherwise the Contractor shall forfeit such instalment.

SECTION 2: MATERIALS AND TESTING OF MATERIALS

205 SOILS AND GRAVEL

All materials testing shall be in accordance with section 2 of the Standard Specifications

SECTION 3 SETTING OUT & TOLERANCES 301 SETTING OUT

- (a) In addition to the provisions of clause 3.01(a) if the traverse points to be used for the setting out are close to the existing carriageway and interfere with construction works then the Contractor will have to relocate them to a location where they will not be disturbed. The co-ordinates and heights of all traverse points so located shall be listed and provided to the Engineer for checking and/or approval.

Contractor shall also monument the new centerline every 200m along straight and all salient points along curves by a pin in the concrete beacon before commencement of any works. The road reserve boundary posts shall have 12mm diameter steel pins embedded in concrete, 200mm long with 25mm exposed to the air, sticking out from its top surface. This pin shall be co-ordinated and heighted and result of the same shall be provided to the Engineer for approval. Cost of these works shall be included in the rates as no separate item has been provided.

Commencement of the works shall not be permitted until this basic survey data has been provided and approved by the Engineer for at least 2 Kms of the road.

- (b) Detailed Setting Out

Reference pegs shall be 50mm by 50mm in section 600mm long driven 400mm firmly into ground and painted white above the ground. The offset from centre line shall be

indicated by small nail 20mm to 25mm long with its head driven flush with the top of the peg. Chainages, offset and reference elevation shall be clearly indicated to the sides of the peg to the satisfaction of the Engineer. After cutting of benches and prior to commencement of earthworks or subgrade works, Contractor shall take cross-sections again and submit the copy of the same to Engineer for agreement. These cross sections shall then be used as basis of measurement for all subsequent layers, unless otherwise stated.

SECTION 4 SITE CLEARANCE AND TOP SOIL STRIPPING

401 SITE CLEARANCE

Site Clearance shall be carried out as directed by the Engineer.

REMOVAL OF TOPSOIL

Topsoil shall include up to 200mm depth of any unsuitable material encountered in existing or newly constructed drains, drainage channels, and accesses.

SECTION 5: EARTHWORKS

504 PREPARATION PRIOR TO FORMING EMBANKMENT

Where benching of the existing pavement is required to accommodate earthworks subgrade or subbase for widening of the road, the rate for compaction of existing ground shall be deemed to cover this activity. Excavation in the pavement of the existing road shall be kept dry.

In the event of water penetrating the underlying layer, construction of the subsequent layers shall be postponed until the underlying layers are dry enough to accommodate the construction plant without deforming or otherwise showing distress.

Step construction shall be carried out per layer at the joint where excavating both vertically and perpendicular to the direction of the travel. The step shall be 500mm perpendicular to the direction of the travel and 150mm vertical unless otherwise instructed by the Engineer. Special care shall be taken when compacting the new material at the joint ensuring that specified density is achieved.

505 CONSTRUCTION OF EMBANKMENTS

Only material approved by the Engineer shall be used for fill in embankments. Material with high swelling characteristics or high organic matter content and any other undesirable material shall not be used, unless specifically directed by the Engineer. Unsuitable material shall include:

- i. All material containing more than 5% by weight of organic matter (such as topsoil, material from swamps, mud, logs, stumps and other perishable material)
- ii. All material with a swell of more than 3% (such as black cotton soil)
- iii. All clay of plasticity index exceeding 50.
- iv. All material having moisture content greater than 105% of optimum moisture content (Standard Compaction)

Subgrade: Shall mean upper 300mm of earthworks either in-situ or in fill and subgrade shall be provided for as part of earthworks operation and payment shall be made as “fill”. The material for subgrade shall have a CBR of not less than 8% measured after a 4-day soak in a laboratory mix compacted to a dry density of 100% MDD (AASHTO T99) and a swell of less than 1%.

Subgrade repair: Where directed by the Engineer, any localized failure in the subgrade shall be repaired by filling in selected soft, hard or natural of minimum CBR 30% and compacted in accordance with clauses in the specifications applying to normal subgrade.

Embankment repair: Where directed by the Engineer, any localized filling in soft, hard or natural; selected material requirements shall be executed with Clause 505.

508 COMPACTION OF EARTHWORKS

At pipe culverts, all fill above ground level around the culverts shall be compacted to density of 100% MDD (AASHTO T.99) up to the level of the top of the pipes or top of the surround(s), if any and for a width equal to the internal diameter of the pipe on either side of the pipe(s) or surround(s) as applicable.

At locations adjacent to structures, all fill above ground level up to the underside of the subgrade shall be compacted to density of 105% MDD (AASHTO T.99).

In case of fill around box culverts this should be carried out for the full width of the fill and for a length bounded by the vertical plane passing through the ends of the wing-walls. Notwithstanding the provision of clause 503 of the standard Specification, Compaction of subgrade material (i.e. material immediately below formation) in cut areas shall not be carried out by the contractor in areas where the formation is formed in hard material, unless the Engineer issues specific instructions to the contrary are issued.

Where improved sub-grade material shall be required, this shall be compacted and finished to the same standards and tolerances as those required for normal subgrade and clauses in the specifications applying to normal subgrade shall also apply.

511 BORROW PITS

The first part of the Standard Specification is amended as follows: - Fill material which is required in addition to that provided by excavation shall be obtained from borrow pits to be located and provided by the Contractor but to the approval of the Engineer contrary to what has been stated.

517 MEASUREMENT AND PAYMENT

Notwithstanding the provisions of clause 517 of the standard specifications, the rate for compaction of fill in soft material shall allow for the requirements of clause 508 of the special specification and no extra payment shall be made for compaction around pipe culverts (100% MDD AASHTO T.99).

SECTION 6 - QUARRIES, BORROW PITS, STOCKPILES AND SPOIL AREAS

601 GENERAL

Notwithstanding any indications to the contrary in the Standard specification the Engineer will not make available to the Contractor any land for quarries, borrow pits, stockpiles and spoil areas, except for those areas in road reserves specifically approved by him.

The contractor will be entirely responsible for locating suitable sources of materials complying with the Standard and Special Specifications, and for the procurement, Wining, haulage to site of these materials and all costs involved therein.

Similarly, the contractor will be responsible for the provision and costs involved in providing suitable areas for stockpiling materials and spoil dumps. Should there be suitable sites for spoil dumps or stockpiles within the road reserve forming the site of the works the Contractor may utilise these subject to the approval of the Engineer.

No additional payment will be made to the Contractor to cover costs arising from the requirements for this Clause and the Contractor must include these costs in the rates inserted into the Bills of Quantities.

602 MATERIAL SITES

The information on possible material sites is given for the general guidance of bidders. Bidders are however advised to conduct their own investigation as the information contained therein is neither guaranteed nor warranted

603 PROVISION OF LAND

Notwithstanding any indications to the contrary in the Standard specification the Engineer will not make available to the Contractor any land for quarries, borrow pits, stockpiles and spoil areas, except for those areas in road reserves specifically approved by him.

The contractor will be entirely responsible for locating suitable sources of materials complying with the Standard and Special Specifications, and for the procurement, Wining, haulage to site of these materials and all costs involved therein.

Similarly, the contractor will be responsible for the provision and costs involved in providing suitable areas for stockpiling materials and spoil dumps. Should there be suitable sites for spoil dumps or stockpiles within the road reserve forming the site of the works the Contractor may utilise these subject to the approval of the Engineer.

No additional payment will be made to the Contractor to cover costs arising from the requirements for this Clause and the Contractor must include these costs in the rates inserted into the Bills of Quantities.

605 SAFETY AND PUBLIC HEALTH REQUIREMENTS

In addition to clause 605, the contractor shall allow for professionals to conduct lectures to the workers regarding the spread of HIV/Aids.

SECTION 7 - EXCAVATION AND FILLING FOR STRUCTURES**703 EXCAVATION OF FOUNDATIONS FOR STRUCTURES**

Unless otherwise instructed by the Engineer, all excavated surfaces in material other than hard material, on which foundations for structures shall be placed, shall be compacted to 100% MDD (AASHTO T.99) immediately before structures are constructed. Thus in Standard Specification, Paragraph 4, last line: - Replace "95%" with "100%".

707 BACKFILLING FOR STRUCTURES

Unless otherwise instructed by the Engineer, all backfilling material shall be compacted to a minimum of 100% MDD (AASHTO T.99).

709 EXCAVATION FOR RIVER TRAINING AND NEW WATER COURSES

Payments for river training and establishment of new watercourses shall only be made where such work constitute permanent works. Works done for road deviation or other temporary works shall not qualify for payment.

712 RIP-RAP PROTECTION WORK

Quarry waste or similar approved material shall be used to backfill scoured and eroded side, outfall and cut-off drain. The material shall be compacted to form a flat or curved surface preparatory to stone [pitching of drainage channels, existing and new scour checks as directed by the Engineer.

The surface to receive the pitching shall be compacted and trimmed to slope and the stone hand laid, interlocked and rammed into the material to give an even finished surface. The interstices of the Pitching shall be rammed with insitu material. The insitu material immediately behind the pitching shall be compacted to minimum density of 100% MDD compaction (AASHTO T.99)

714 BACKFILL BELOW STRUCTURES

Where instructed this shall be carried out in compliance with the requirements of Clause 507 and 804 of the Standard Specification.

SECTION 8 - CULVERTS AND DRAINAGE WORKS

801 SCOPE OF SECTION

The operations specified in this section apply to the installation of drainage works and reinstatement and improvement of the same. In addition, this Section covers: - -
Extending of existing 450mm, 600mm and 900mm diameter pipes to be compatible with the increased road width or access. - Desilting and cleaning of existing pipes and outfall drains to make them free flowing.

804 EXCAVATION FOR CULVERTS AND DRAINAGE WORKS

In the Standard Specifications, make the following amendments: -

- (a) In paragraph 6, line 3, and in paragraph 7, line 5 and in paragraph 11, line 6, delete "95%" and insert "100%".
- (b) Removal of Existing Pipe Culverts Where instructed by the Engineer, the Contractor shall excavate and remove all existing blocked or collapsed culvert pipes of 450mm, 600mm and 900mm diameter including concrete surround, bedding, inlet and outlet structure.

The void left after removal of culvert pipes shall be widened as necessary to accommodate new concrete bedding, pipe and haunching. The payment of this work

shall be per linear metre of pipes removed, and the volume in m³ of inlet/outlet structure removed.

The void left by removal of these pipes shall be carefully preserved in order to accommodate replacement of 450mm, 600mm or 900mm diameter pipe culverts as shall be directed by the Engineer.

- (c) Removal of Other Existing Drainage Structures When instructed by the Engineer, the Contractor shall demolish or remove any other structure and payment for this shall be made on day work basis.
- (d) Excavation for Culverts and Drainage Works the Contractor shall carry out all excavations for new culverts and drainage works to the lines, levels, inclinations, and dimensions shown on the drawings or as instructed by the Engineer.

805 EXCAVATION IN HARD MATERIAL

In the Standard Specifications, Sub-clauses 805(a) and 805 (b) delete "95%" and insert "100%".

In sub-clause 809(a), paragraph 1, line 1, substitute "95%" with "100%".

In sub-clause 809(c), paragraph 2, line 4, between the words "compacted" and "and shaped" insert the words "to 100% MDD (AASHTO T.99)". Hard material is material that can be excavated only after blasting with explosives or barring and wedging or the use of a mechanical breaker fitted with a rock point in good condition and operated correctly. Boulders of more than 0.2m³ occurring in soft material shall be classified as hard material.

809 BEDDING AND LAYING OF PIPE CULVERTS

Concrete pipes shall be laid on a 150mm thick concrete bed of class 15/20 and the pipes shall be bedded on a 1:3 cement: sand mortar at least 50mm thick, 150mm wide and

extending the full length of the barrel. The rates inserted shall allow for compaction of the bottom of excavation to 100% MDD (AASHTO T.99).

810 JOINTING CONCRETE PIPES

The concrete pipes for the culverts shall have ogee joints and will be jointed by 1:2 cement: sand mortar and provided with fillets on the outside as described in clause 810 of the Standard Specification.

812 BACKFILLING OVER PIPE CULVERTS

In the Standard Specifications, clause 812 a) Wherever the expression "dry density of 95% MDD (AASHTO T. 99)" occurs delete and replace with "dry density of 100% MDD (AASHTO T.99)". The rates entered for laying of pipe culverts shall allow for backfilling to pipe culverts and compacting to 100% MDD (AASHTO T.99) and these works shall not be measured and paid for separately.

814 SUBSOIL DRAINS

In the event of excavation for repairs exposing local seepage, springs or unacceptably high water table, the Engineer may instruct the provision of counter fort or French drains. These drains shall consist of a trench excavated to the alignment, width, depth and gradient instructed by the Engineer, and backfilled with approved compacted clean hard crushed rock material as specified in clause 815 of the standard specification. Where these drains lie within the carriageway the carriageway shall be reinstated with compacted stabilised gravel and surfaced with hot asphalt or a surface dressing as instructed by the Engineer.

815 INVERT BLOCK DRAINS AND HALF ROUND CHANNELS

Invert Block Drains and Half Round Channels shall be constructed as shown in the drawings provided in accordance with the Standard Specifications where directed by the Engineer.

817 REPAIRS TO DRAINS

817.1 Cleaning, construction and Repair of Existing Drains

In areas of existing side drains, mitre or outfall drains where such are blocked, the Engineer shall instruct the Contractor to clean and clear the drains to free flowing condition.

The work shall consist of:

- a) Stripping and removal of any extraneous material to spoil including vegetation and roots in the drains to the satisfaction of the engineer.
- b) Spreading of any spoil to the satisfaction of the Engineer. Shaping the drains to free flowing condition as directed by the Engineer and:
 - i. Removing any broken side slabs for inverted block drains and replacing with new ones.
 - ii. Or removing any broken inverted block drains and replacing with Concrete class 20/20 and A142 BRC reinforcement.

Measurement and Payment for cleaning drains shall be by linear metre of drain cleaned measured as the product of plan area and vertical depth of extraneous material instructed to be removed.

Where insitu concrete is used measurement will be on cubic metre of concrete and BRC area or weight in relevant unit e.g. Kg, Tonnes etc.

No extra payment will be made for removal of vegetation and roots.

817.2 Channels

The Engineer may instruct that the Contractor provides open channels in place of existing sub drains where the latter may be damaged or in any other place. The rates entered by the Contractor in the bills of quantities must include for removal and disposal of any sub drain material, excavation to line and level, backfilling and compaction as directed by the engineer.

The channels shall be constructed of precast class 20/20 concrete of minimum 80mm thickness and lengths or widths not exceeding 1000mm. Joints shall be at least 15mm wide filled with 1:2 cement sand mortar.

817.3 Rubble fills for protection work

Quarry waste or similar approved material shall be used to back fill scoured and eroded side, outfall and cut-off drains. The material shall be compacted to form a flat or curved surface preparatory to stone pitching of drainage channels, existing and new scour checks as directed by the Engineer.

817.5 Gabions

Gabions shall be constructed in accordance with clause 711 of the standard Specification.

817.6 Spoil Material

The Contractor shall be responsible for removal from site of all materials excavated in the course of undertaking works in this section of the specifications, unless suitable for re-use, and deposit of the material in a spoil dump to be approved by the Engineer.

818 SCOUR CHECKS

Scour checks are to be constructed in mass concrete in accordance with clause 818 of the standard Specifications and the drawings as shall be provided.

819 CLEANING AND MAINTENANCE

819.1 Desilting of Pipe Culverts

Where instructed, Contractor shall desilt the existing pipe culverts by removing all the material from the pipe to make them clean and free flowing. Measurement and payment shall be by the linear metres of pipes de-silted, regardless of diameter size.

SECTION 9 - PASSAGE OF TRAFFIC

903 MAINTENANCE OF EXISTING ROADS

The Contractor shall maintain the existing project road ahead of works using compacted asphalt concrete type I in accordance with the provisions in clause 1601B – 1607B of the Special Specifications or gravel material depending on the nature of the wearing course surface.

904 CONSTRUCTION OF DEVIATIONS

(a) General

In addition to requirement of this clause, the Contractor shall construct and complete deviations to the satisfaction of the Engineer before commencing any permanent work on the existing road. Also during these works the contractor is supposed to provide a detour of adequate pipe culverts for pedestrian and traffic crossing where there is bridge works.

Subject to the approval by the Engineer, the Contractor may maintain and use existing roads for deviation. Payment for this, made in accordance with clause 912 (a) (i), shall be by the Kilometer used depending on the type of road used, whether bituminous or earth/gravel. The rates shall include for the provision of materials and the works involved.

(b) Geometry

- i The carriageway width of the deviations shall not be less than 6m wide and suitable for 2-way lorry traffic unless otherwise specified.
- ii The carriageway width of the deviations shall not be less than 3.5 m wide and suitable for 1-way lorry traffic unless otherwise specified.

(c) Construction

Unless otherwise instructed gravel wearing course for the deviation shall be 150 mm compacted thicknesses complying with section 10 of the Standard Specification.

The CBR at 4-day soak shall not be less than 25 and the PI range shall be 15- 20. The Contractor shall allow in his rate for removal of any unsuitable material before placing of gravel wearing course, as this will not be paid for separately. In addition to provision of this clause, Contractor is required to sprinkle water at least 4 times a day at the rate of 1 to 1.4 litres/Square meter in regular interval to minimise the effects of dust. Latest sprinkling time shall be one hour before the sunset. Where existing neighboring roads are used as deviation, Contractor shall carry out repairs and maintenance in parent materials used for the existing base and surfacing of the road being used.

906 PASSAGE OF TRAFFIC THROUGH THE WORKS

The Contractor shall arrange for passage of traffic through the works during construction whenever it is not practicable to make deviations. Any damage caused by passing traffic through the works shall be made good at the contractor's own cost.

907 SIGNS, BARRIERS AND LIGHTS

Contractor shall provide signs, barriers and lights as shown in the drawing in Book of Drawings at the locations where the traffic is being carried off the existing road to the deviation and back again to existing road. The Contractor shall provide ramps and carry out any other measures as instructed by the Engineer to safely carry traffic from the road to deviation. Contrary to what has been specified in this clause the road signs provided shall be fully reflectorized and in conformity with clause 9.1 of the "Manual for Traffic Signs in Kenya Part II".

909 ASSISTANCE TO PUBLIC

In addition to provision of clause 909, Contractor shall maintain close liaison with the relevant authorities to clear any broken down or accident vehicles from the deviations and the main road, in order to maintain smooth and safe flow of the traffic.

Further, the Contractor shall provide a traffic management plan to be approved by the Engineer before the commencement of any construction works and execute the same, to the satisfaction of the Engineer, during the entire period of project implementation.

A draft traffic management plan shall be submitted with Bid.

912 MEASUREMENT AND PAYMENT

Construct Deviation

Road Deviation

The Contractor shall be paid only 50% of the rate when he completes deviation road to the satisfaction of the Engineer. The balance shall be paid in equal monthly instalments over the contract period, as he satisfactorily maintains the deviation (as per clause 904 and 905 above) when it is in operation.

Where existing neighboring road has been used as deviation, payment shall be by the kilometre rate and shall include the cost of repairs and maintenance of the road carried out in parent base and subbase materials.

Maintain existing road

Asphalt Concrete or gravel for maintaining the existing road shall be measured by the cubic metre placed and compacted upon the road

Passage of traffic through the works

Payment shall be made on Lump Sum basis.

Assistance to Public

The Contractor will be deemed to have included cost of this item in other items and no separate payment shall be made.

SECTION 10: GRADING AND GRAVELLING

1001 SCOPE:

Grading covers the works involved in the reinstatement of the carriageway to the camber by removing the high points and filling up gullies corrugations and wheel ruts to restore smooth running surface. Gravelling consists of excavation, loading hauling and spreading of gravel wearing course material on the formation of carriageway. Gravel shall include lateritic gravel, quartzitic gravel, calcareous gravel, decomposed rock, soft stone coral rag, clayey sand and crushed rock.

The material may be obtained from borrow pits or excavation in cuttings. Gravel material shall conform to the requirement given in **Table 10.1**

TABLE 10.1

GRADING REQUIREMENTS AFTER COMPACTION		PLASTICITY REQUIREMENTS PI INDEX		
Sieve (mm)	% by Weight Passing	Zone	Min	Max
40	100			
28	95 – 100	WET	5	20
20	85 – 100			
14	65 – 100	DRY	15	20
10	55 – 100			
5	35 – 92			
2	23 – 77			
1	18 – 62			
0.425	14 – 50			
0.075	10 – 40			

BEARING		STRENGTH	
Traffic VPD	CBR	DCP Equivalent mm/Blow	
Greater than 15	25	11	
Less than 15	20	14	
CBR at 95 % at MDD, Modified AASHTO and 4 days soak			
Lower quality material (CBR 15) may be accepted if no better material can be found			

NB: Wet Zone - mean annual rainfall greater than 500 mm.

Dry zone - mean annual rainfall less than 500 mm.

The Engineer shall approve quarries and their extent of exploitation. The quarries shall be shown to the Contractor prior to commencement of the Works. The Contractor shall be responsible for the acquisition of the quarry rights and shall therefore conduct respective negotiations with landowners and affected communities.

Alternative sources of gravel material whose quality can be shown to be in compliance with the specification requirements may be used, with the proviso that the Employer is not to incur additional expenses in connection with its winning and haulage. Contractor is deemed to have included in his rates for the provision of the gravel material to have included the cost of complying with the testing requirements.

1002 Removal of Overburden

The Item consists of excavation of overburden including loading, hauling and stockpiling at the approved locations. The thickness of the overburden layer to be removed shall be determined from the depths of the trial pits dug at a 30m grid within the quarry area.

The overburden shall be removed and deposited neatly in order to use it again to reinstate the quarry at the end of improvement work.

Work Method:

The contractor shall use **labour** or **equipment** to carry out this item of work

Quality Control

The location and manner of stock piling of the overburden for the reinstatement of the quarry shall be visually checked

Measurement and Payment

No separate measurement and payment shall be made for removal of overburden and contractor shall be deemed to have allowed in his rates and prices for the cost.

1003 Excavation of Gravel

The gravel shall be excavated from quarries approved by the Engineer. It is the Contractors obligation to inform the Engineer in the case that the quality / availability of the gravel changes during the course of excavation.

Oversize stones and boulders shall be removed from the excavated gravel and deposited outside the quarry at locations approved by the Engineer. Such stones and boulders may be reused for structures and scour checks

Work Method**i Labour based methods**

The contractor shall excavate and stockpile the gravel in bays for efficient loading by labour.

ii Equipment methods

The Contractor shall excavate the gravel and stockpile in heap(s) for the efficient loading by equipment.

Quality Control

- The widths of the loading bays shall be checked before excavation can commence.
- The loading bays shall be checked to ensure it is free draining.

Measurement and Payment

No separate measurement and payment shall be made for excavation of gravel and contractor shall be deemed to have allowed in his rates and prices for the cost.

1004 Haulage

This activity involves loading of excavated gravel, haulage by appropriate equipment and off-loading of the same as specified in the drawings or as directed by the Engineer.

Where the loads delivered in any load falls short of agreed equipment capacity, dumping shall not be permitted unless the agreed spacing is adjusted accordingly.

Where loads supplied are found to contain material other than from the approved quarry and thus of unacceptable quality, the Engineer shall cause them to be removed from site at the contractor's expense.

Work Method

The Contractor shall use a combination of both Labour and equipment to carry out this Item work.

Quality Control

- No haulage equipment shall be used unless its capacity has been ascertained the Engineer.

- The quality of gravel dumped on the carriageway/carrigeway shall be visually checked daily.
- The quantity of material delivered in each load shall be checked before dumping is allowed.
- The distance between the stacks shall be checked using tape measure.

Measurement and Payment

No separate measurement and payment shall be made for haulage of gravel and contractor shall be deemed to have allowed in his rates and prices for the cost.

1005 Spreading and compaction of gravel

i. Labour methods

ii. Equipment methods

This activity involves spreading gravel material, shaping to ensure uniform thickness of the layer across the full width of the carriageway and to the specified camber. Spreading also includes, removing any oversized stones or boulders which cannot be broken down to required size, spoil dump.

Where water needs to be added, it shall be applied in an even manner and the rate of application shall be such that no transverse or longitudinal flows occur. Unless otherwise instructed by the Engineer, the moisture content shall be within the range of +/- 2% of the optimum moisture content. Compaction will be carried out as specified in 5.05.

Work Method

The Contractor shall use **Labour** or Equipment to carry out this Item work.

Quality Control

- The gravel surface width shall be checked at every 100m interval using tape measure and shall have tolerance of + / - 50mm.
- Trial holes at every 100m shall be used to check the gravel surface thickness and shall have a tolerance of + 5mm / - 0mm.
- The camber cross fall shall be checked at every 50m and the maximum tolerances shall be + / - 1 %
- The longitudinal profile shall be checked with every load to ensure a smooth surface with no corrugations or depressions

Measurement: m^3

The unit of measurement shall be in cubic metres of compacted material on carriageway

Payment

The unit rate shall be the full compensation for labour, tools, equipment and any incidental costs required for carrying out the work.

1006 Carriageway Grading**(i) Light Grading**

This activity shall consist of trimming of the carriageway to control roughness and corrugations using either a towed grader or a motorized grader. The width of the carriageway shall be as specified in the drawings or as directed by the Engineer.

Pegs 200 to 300mm shall be placed at 10 to 20 m intervals to mark edge of the carriageway.

The material shall be bladed toward the center of the carriageway starting from both edges to the specified camber.

Work Method

The contractor shall use equipment to carry out this item work.

Quality Control

- The width of the carriageway shall be checked using tape measure at every 10m with tolerance of +50mm or -20mm.
- The camber shall be checked using camber board at every 5m with and shall have a tolerance of +/- 1%

Measurement: m^2

The unit of measurement shall be square meters of carriageway graded.

Payment

The unit rate shall be the full compensation for labour, equipment and any incidental costs required for carrying out the work.

ii) Heavy Grading and Compaction

This activity shall consist of scarifying of the existing carriageway/carriageway surface, cutting high spots and moving materials to fill potholes, corrugations and wheel ruts and

reshaping of the surface to the specified camber, using either towed or motorized grader. All loose rocks, roots grasses shall be removed and disposed well clear of the drains.

Pegs 300 to 400mm shall be placed at 10 to 20 m intervals to mark edge of the carriageway.

The material shall be bladed toward the center of the carriageway starting from both edges until the specified camber is achieved. Compaction will be carried out as specified in 5.05.

Work Method

The contractor shall use equipment to carry out this item work.

Quality Control

- The width of the carriageway shall be checked using tape measure at every 10m with tolerance of + 50mm or -20mm.
- The camber shall be checked using camber board at every 5m with and shall have a tolerance of +/- 1%

Measurement: **m²**

The unit of measurement shall be square meters of carriageway graded.

Payment

The unit rate shall be the full compensation for labour equipment and any incidental costs required for carrying out the work.

1007 Restoration of Quarries and Borrow pits

The ground shall be levelled, topsoil hauled back and uniformly spread over the entire exposed/excavation area.

Adequate drainage provisions shall be made to protect excavation areas. Where necessary appropriate protection measures may be taken to avoid erosion of the spread topsoil layer. Grass and trees may be replanted as directed by the Engineer.

SECTION 17 - CONCRETE WORKS

1703 MATERIALS FOR CONCRETE

This work shall consist of placing selected approved material of 250mm minimum diameter on the foundation put after excavation to receive levelling concrete in accordance with these specifications and in conformity with the lines, grades and cross sections shown on the Drawings as directed by the Engineer.

(a) Materials

Selected rock: The selected rock builders to be placed for this work shall be hard, sound, durable quarry stones as approved by the Engineer. Samples of the stone to be used shall be submitted to and approved by the Engineer before any stone is placed.

The maximum size of the stone boulders shall be 300mm.

(b) Construction Method

After completion of the structural excavation the surface of the loose soil shall be levelled and compacted. Then the stone of the above sizes shall be placed in one layer of 250mm over the compacted bed where the bottom slab will rest. Coarse sand shall be spread to fill up the voids in the stone boulders, and compaction with vibratory compactors should be performed to make this layer dense whereon a concrete of levelling course shall be placed.

(c) Measurement and payment

Measurement for the bedding materials shall be made in cubic metres for the completed and accepted work, measured from the dimension shown on the Drawings, unless otherwise directed by the Engineer.

Payment for the bedding Materials for Levelling Concrete Works shall be full compensation for furnishing and placing all materials, all labour equipment, tools and all other items necessary for proper completion of the work in accordance with the Drawings and specifications and as directed by the Engineer.

**1703(A) LEVELLING CONCRETE (CLASS 15/20) FOR BOTTOM SLAB
INCLUSIVE OF COST OF FORM WORKS**

This work shall consist of placing and levelling lean concrete class 15/20 over the prepared bed of stone boulders in the foundation for bottom slab and wing walls in accordance with these specifications and which conformity with the lines, grades, thickness and typical cross-sections shown on the drawings unless otherwise directed by the Engineer.

(a) Materials for Levelling Concrete

Requirement for the concrete class 15/20 is specified as follows: -

Design compressive strength (28) days : 15N/mm²

Maximum size of coarse aggregate : 20mm

Maximum cement content : 300 kg/m³.

Maximum water/cement ration of 50% with slump of 80mm.

(b) Construction Method

The bed of stone boulders upon which the levelling concrete will be placed shall be smooth, compacted and true to the grades and cross-section shall be set to the required lines and grades.

(c) Measurement and payment

Measurement for levelling concrete (class 15/20) shall be made in cubic metres completed and accepted levelling concrete work measured in place which is done in accordance with the Drawings and the Specifications.

Payment for this work shall be the full compensation for furnishing and placing all materials, labour, equipment and tools, and other incidentals to Specifications and as directed by the Engineer.

Pay item No. 17/02 Levelling Concrete Works (Class 15/20) for Box Culvert and wing walls inclusive of Cost of Form works.

1703 (C) FORMWORK FOR CULVERT WALLS

This work shall consist of all temporary moulds for forming the concrete for culvert walls and slabs together with all temporary construction required for their support. Unless otherwise directed by the Engineer all formworks shall be removed on completion of the walls and slabs.

(a) **Materials**

Forms shall be made of wood or metal and shall conform to the shape, lines and dimensions shown on the Drawings.

All timber shall be free from holes, loose material, knots, cracks, splits and warps or other defects affecting the strength or appearance of the finished structure.

Release Agents – Release agents shall be either neat oils containing a surface activating agent, cream emulsions, or chemical agents to be approved by the Engineer.

(b) **Construction Method**

(i) **Formworks**

Formworks shall be designed to carry the maximum loads that may be imposed, and so be rigidly constructed as to prevent deformation due to load, drying and wetting, vibration and other causes. After forms have been set in correct location, they shall be inspected and approved by the Engineer before the concrete is placed.

If requested, the contractor shall submit to the Engineer working drawings of the forms and also, if requested, calculations to certify the rigidity of the forms.

1703(D) CONCRETE WORKS (CLASS 20/20)

This work shall consist of furnishing, mixing, delivering and placing of the concrete for the construction of culvert walls and slabs, in accordance with these Specifications and in conformity with the requirements shown on the Drawings.

Concrete class 20/20 shall be used as directed by the Engineer.

(a) **Concrete Materials**

(i) **Cement:** Cement shall be of Portland type and shall conform to the requirements of BS 12 or equivalent.

The contractor shall select only one type or brand of cement or others. Changing of type or brand of cement will not be permitted without a new mix design approved by the Engineer. All cement is subject to the Engineer's approval, however, approval of cement by the Engineer shall

not relieve the Contractor of the responsibility to furnish concrete of the specified compressive strength.

Conveyance of cement by jute bags shall not be permitted. Storage in the Contractor’s silo or storehouse shall not exceed more than two (2) months, and age of cement after manufacture at mill shall not exceed more than four (4) months. The Contractor shall submit to the Engineer for his approval the result of quality certificate prepared by the manufacturer.

Whenever it is found out that cement have been stored too long, moist, or caked, the cement shall be rejected and removed from the project.

(b) Aggregates

Fine and coarse aggregates must be clean, hard, strong and durable, and free from absorbed chemicals, clay coating, or materials in amounts that could affect hydration, bonding, strength and durability of concrete.

Grading of aggregates shall conform to the following requirements:

Sieve Size	Percentage by Weight Passing
10 mm	100
5 mm	89-100
2.5 mm	60-100
1.2 mm	30-100
0.6 mm	15- 54
0.3 mm	5- 40
0.15 mm	0 - 15

(ii) Grading of Coarse Aggregates

Size of	Amounts finer than each standard sieve percentage by weight
---------	---

Coarse Aggregate	40	30	25	20	15	10	5	2.5
	100	-	-	90-100	-	30-69	0-10	-
	-							

Other requirements for aggregates are as follows:

(iii) **Fine Aggregates**

- Fitness Modulus, AASHTO M-6 : 2.3 – 3.1
- Sodium Sulphate Soundness, AASHTO T104 : Max. 10% loss
- Content of Friable Particles AASHTO 112 : Max 1% by weight
- Sand Equivalent, AASHTO T176 : Min. 75

(iv) **Coarse Aggregate**

- Abrasion, AASGTO T96 : Max. 405 loss
- Soft Fragment and shale, AASHTO M80 : Max. 5% by weight
- Thin and elongated Pieces, AASHTO M80 : Max. 15%

(v) **Water**

All sources of water to be used with cement shall be approved by the Engineer. Water shall be free from injurious quantities of oil, alkali, vegetable matter and salt as determined by the Engineer.

(vi) **Admixture**

Only admixture, which have been tested and approved in the site laboratory through trial mixing for design proportion shall be used.

Before selection of admixture, the Contractor shall submit to the Engineer the specific information or guarantees prepared by the admixture supplier.

The contractor shall not exclude the admixture from concrete proportions.

Concrete class 20/20

Concrete class 20/20 shall be used as directed by the Engineer. The requirements of Concrete class 20/20 are provided as follows unless otherwise the Engineer will designate any alteration.

Design compressive strength (28 days) : 20N/mm²

Maximum size of coarse aggregates : 20mm

Maximum water/cement ratio of 45% with slump of

80mm

(d) Proportioning Concrete

The Contractor shall consult with the Engineer as to mix proportions at least thirty (30) days prior to beginning the concrete work. The actual mix proportions of cement, aggregates, water and admixture shall be determined by the Contractor under supervision of the Engineer in the site laboratory.

The Contractor shall prepare the design proportions which has 120% of the strength requirement specified for the designated class of concrete.

No class of concrete shall be prepared or placed until its job-mix proportions have been approved by the Engineer.

(e) Concrete Work

BATCHING

Batching shall be done by weight with accuracy of:

Cement : ½ percent

Aggregate : ½ percent

Water and Admixture : 1 percent.

I. EQUIPMENT SHOULD BE CAPABLE OF MEASURING QUANTITIES WITHIN THESE TOLERANCES FOR THE SMARTEST BATCH REGULARLY USED, AS WELL AS FOR LARGER BATCHES.

The accuracy of batching equipment should be checked every month in the presence of the Engineer and adjusted when necessary.

iii. Mixing and delivery

Slump of mixed concrete shall be checked and approved at an accuracy of +25mm against designated slump in these specifications.

iv. Concrete in hot weather

No concrete shall be placed when the ambient air temperature is expected to exceed thirty-three degrees Celsius (33⁰c) during placement operations).

v. Concreting at night

No concrete shall be mixed, placed or finished when natural light is insufficient, unless an adequate approved artificial lighting system is operated, such night work is subject to approval by the engineer.

vi. Placing

In preparation of the placing of concrete, the interior space of forms shall be cleaned and approved by the engineer prior to placing concrete. All temporary members except tie bars to support forms shall be removed entirely from the forms and not buried in the concrete. The use of open and vertical chute shall not be permitted unless otherwise directed by the engineer.

The Contractor shall provide a sufficient number of vibrators to properly compact each batch immediately after it is placed in the forms.

(f) **Measurement and Payment**

Measurements for the Concrete Works Class 20/20 of culvert walls and slabs shall be made in cubic metres for the walls and slabs actually constructed, measured from their dimensions shown on the Drawings. Payment for the Concrete Works (Class 20/20) of culvert walls and slabs shall be the full compensation for furnishing all materials of the concrete mixing, delivering, placing and curing the concrete, equipment and tools, labour and other incidental necessary for the completion of the work in accordance with the Drawings and these Specifications and as directed by the Engineer.

SECTION 20 - ROAD FURNITURE

2001 ROAD RESERVE BOUNDARY POSTS

Road reserve boundary posts shall be provided as directed by the Engineer as per the attached drawings and in compliance with Standard Specification clause 2001.

The road shall be referenced at an interval of 250m or as instructed by the Engineer and at right angles to the center line.

The concrete mix used for reference markers shall be of class 20/20.

The monument shall be IPC (Iron Pin in Concrete) of 4 No. T10mm having a total length of 1.65m with 1.35m and 0.45m above and below the ground level respectively.

The part above the ground level shall be square top of width 300mm and height of 1.35m. The part below the ground level shall be conical in shape with the top base diameter of 300mm and base diameter of 600mm and depth 0.45m.

The monument shall be precast as one piece. The inscription KeNHA shall be done on one side of each reference marker.

After erecting the monument, the bottom part shall be concreted with concrete of class 15/20. (and there after curing done for 7 days.

2003 EDGE MARKER POST

Edge marker post shall be provided as directed by the Engineer and in compliance with Standard Specification clause 2003

2004 PERMANENT ROAD SIGNS

Permanent Road Signs shall be provided as directed by the Engineer and in compliance with the requirements of the "Manual for Traffic Signs in Kenya" Part II and standard Specification clause 2004.

2004B EXISTING ROAD SIGNS

Where directed by the Engineer, the Contractor shall take down road signs including all posts, nuts, bolts and fittings, and remove and dispose of the concrete foundation and backfill the post holes. The signs shall be stored as directed by the Engineer.

Measurement and payment for taking down road signs shall be made by the number of signs of any type and size taken down, cleaned and stored as directed.

2005 ROAD MARKING

Paint for road marking shall be internally reflectorized hot applied thermoplastic material in accordance with Clause 219 of the Standard Specification.

The rates inserted in the Bills of Quantities for road marking shall include for prior application of approved tack coat.

2005A RAISED PAVEMENT MARKERS – ROAD STUDS MATERIAL

Road studs are moulded of acrylonitrile butadiene styrene (ABS) conforming to ASTM Specification D1788 – 68, class 5-2-2 shell filled with inert, thermosetting compound and filler. The lens portion of the marker of the marker is of optical menthlymethacrylic.

CONSTRUCTION

The road studs shall be constructed of high impact ABS containing a multi-biconvex glass lens reflector system. It shall be of monolithic construction, and not less than 98.5. m². The height of the marker shall not exceed 17mm and the underside shall contain a non-honeycomb base (flat).

REQUIREMENTS

The markers shall conform to the following requirements

Colour

Shall be white, yellow or red as specified and the Retro – reflectance values should conform to the testing procedures of ASTM E 809.

Impact Resistance

The marker shall not crack or break when tested using a 1000-gram weight from a height of 1 metre. (ASTM D 2444) or BS 3900 Part E3.

Resistance to Water Penetration

Shall not have water penetration behind the lens after submerged in a water bath at 70 + 50 °F for 10 minutes. And it should still meet the reflectance Requirement. BS 998.

Heat Resistance

Shall comply with the initial brightness as per BS 873 Part IV of 1978

Night Visibility

The marker shall be bright as per BS 873 Part IV of 1978

Compression Resistance

There shall be no cracking sound at a pressure lower than 25 tones as per BS 873 Part IV of 1978.

Corrosion Resistance

After immersing a sample of Road stud in a solution containing 30g/l of sodium chloride for 30 days, there shall not be any signs of corrosion -(BS998).

NOTE: These markers are intended for application directly to pavement surfaces and are compatible with raised pavement markers. These adhesives should be of high quality and tested for conformance to customer requirements.

ADHESIVES

They shall be of Resin Type–Epoxy of 2 different components part 1 and 2 i.e Adhesive and Reactor without any volatile solvents in both.

Pot life:	not less than 20 minutes at 20 °C
Rotational cure time:	between 20 and 30 minutes at 20 °C
Hard cure:	Between 40 and 60 minutes at 20 °C

APPLICATION INSTRUCTION

Preparation of Pavements

Make sure that the road surface is absolutely dry and free of oil and grease.

Mixing of Adhesive

Pour component B into the container of component A. Stir mixture by hand with a wooden or metal stick until uniform Grey Tint without a strike is obtained.

Installation

Pour the mixture on to the underside of the road stud. Then place the road stud firmly on the road surface. Adhesive should stand out for about 5mm to 10 mm over the edges of the stud.

Protection from the Traffic

Protect studs from traffic for 2 hours until the adhesive has properly hardened. Try by touching the adhesive.

NUMBER OF STUDS NEEDED FOR LABORATORY TESTS.

In order to approve a particular type of road stud, 4 sample road studs of each colour shall be submitted.

2006 GUARDRAILS

Contrary to the Standard Specification, guardrail posts shall be concrete 200 mm diameter set vertically at least 1.2m into the shoulder as directed by the Engineer. Spacer blocks shall also be made of concrete.

Beams for guardrails shall be "Armco Flexbeam" or similar obtained from a manufacturer approved by the Engineer.

2007 KERBSa) **Vertical Joints**

Vertical joints between adjacent Kerbs shall not be greater than 5 mm in width and shall be filled with a mortar consisting of 1:3 cement: sand by volume.

b) **Transition between flush and raised kerbs**

The transition between flush and raised kerbs (e.g. at bus bays) shall be termed as ramped kerbs. The transition between flush and raised kerbs shall occur within a length of 2.0 m.

2008 EDGE MARKER POSTS

Edge marker posts shall be provided as directed by the Engineer and in compliance with Standard Specification clause 2008.

2009 RUMBLE STRIPS

Where directed by the Engineer, the Contractor shall provide, place, trim, shape and compact to line and level asphalt concrete rumble strips on the finished shoulders. This shall be done to the satisfaction of the Engineer

2010 BOLLARDS

Where directed by the Engineer, the Contractor shall provide, and install 150mm diameter steel encased bollards. The Bollards shall be concreted 300mm into the ground and 900mm above the ground, they shall be painted and marked with two strips of retro reflective yellow tape around the post. Concrete shall be class 15/20.

2011 MEASUREMENT AND PAYMENT**Road reserve boundary posts**

Road reserve boundary posts shall be measured by the number erected

Permanent road signs

Permanent road signs shall be measured by the number of each particular size erected.

Road marking

Road markings in yellow or white material shall be measured in square metres calculated as the plan area painted.

Road Studs

Road studs shall be measured by the number of each particular size erected.

Guardrail

Guardrail shall be measured by the metre as the length of the guardrail constructed.

Kerbs

Kerbs shall be measured by the metre as the length of kerb constructed

SECTION 22-DAYWORKS

2202 MEASUREMENTS AND PAYMENT

(a) Plant

Where items of major plant listed in the schedule of Day works are specified by type (e.g. Concrete mixer etc.) the power rating if such items of plant are provided by the Contractor shall not be lower than the power ratings of such plant manufactured within the last two years prior to the date of BID. Any item of major plant employed upon Dayworks that has a power rating lower than specified above shall be paid for at rates lower than those in the schedule of Dayworks. The reduction in the rate payable shall be in proportion to the reduction in power rating below that specified above.

SECTION 23: CONCRETE PAVING BLOCKS

This works shall consist of providing, laying and fixing of concrete paving blocks and concrete paving slabs on a sand base on the driveway and walkways and other areas as directed by the Engineer.

a. Concrete Paving Blocks

The paving blocks shall be of type S of any shape fitting within a 295 mm square coordinating space and a work size thickness of at least 30 mm. The blocks shall confirm to the requirements of BS 6717: Pt. 1:1986 or Kenya standard equivalent.

The laying shall be broken at intervals of 50 m by concrete ribs of class 25 concrete.

The blocks shall be laid on a 40 mm minimum sand base whose specifications are as in section (b) of this specification.

b. Sand for Sand Base

Sand used as bedding for paving blocks and slabs shall be natural sand either pit or river sand. The grading shall conform and be parallel as much as possible to KS02 – 95 Parts 1 & 2: 1984 for zones 1, 2 or 3. The other requirements shall be as specified in section 1703 (c) of Standard Specifications.

c. Measurement and Payment

Payment for paving blocks and paving slabs shall be by square metre laid. The rate quoted would include the cost of haulage to site of the blocks, slabs and sand, as no extra payment shall be made for haulage

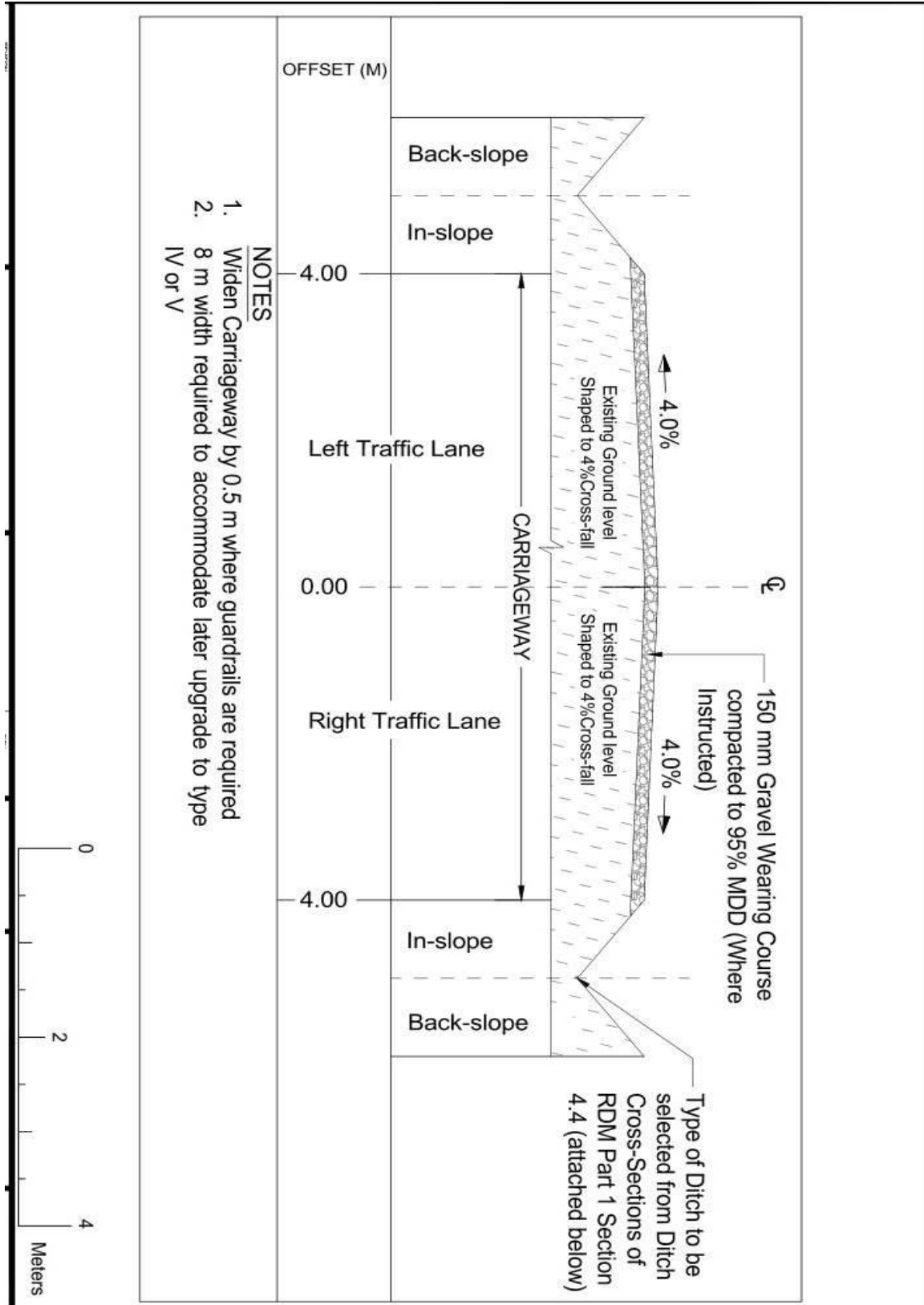

SIDE DITCHES AND CUT OFF DITCHES

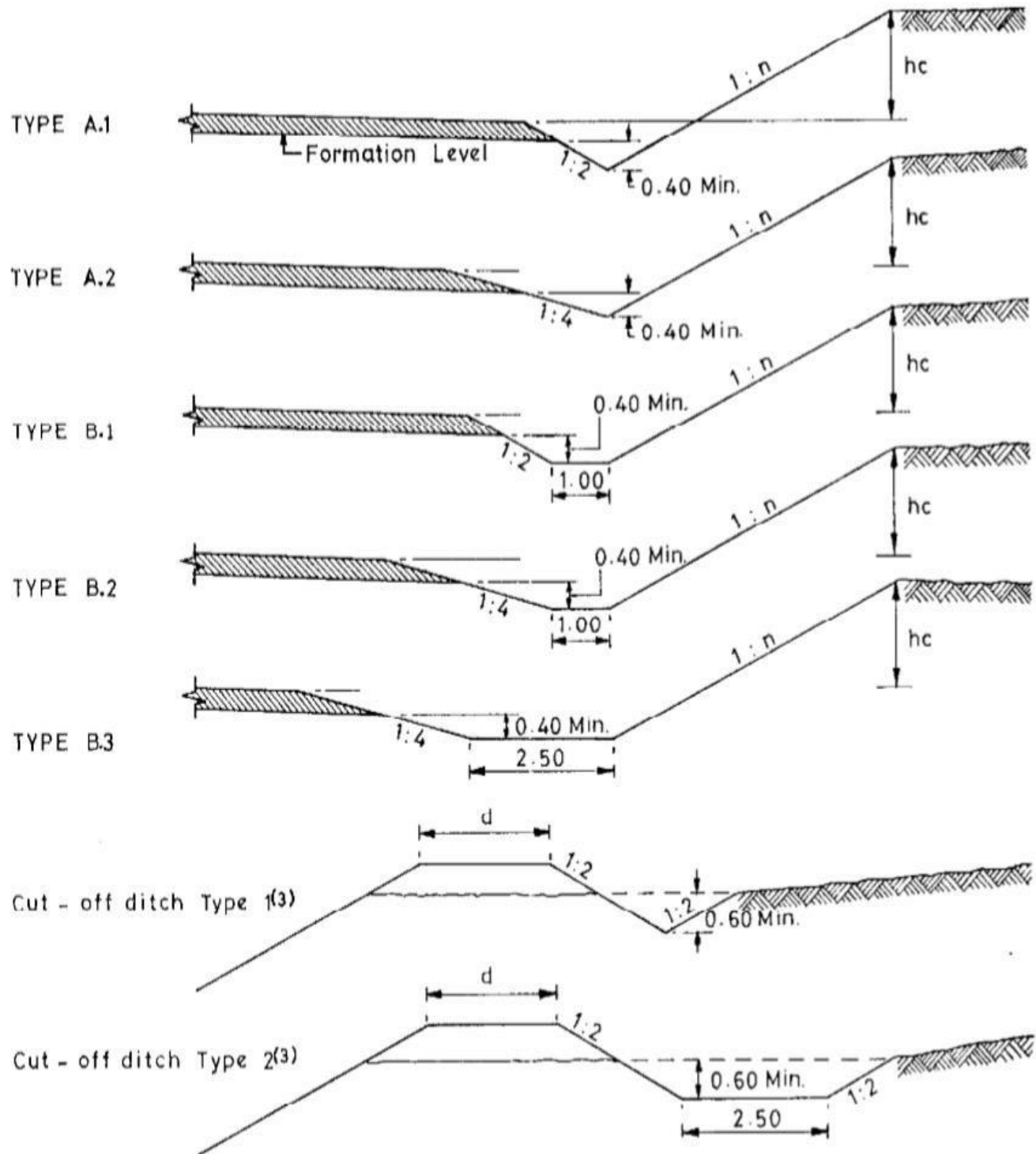

EXTENT AND TYPE OF VEGETATION CONTROL

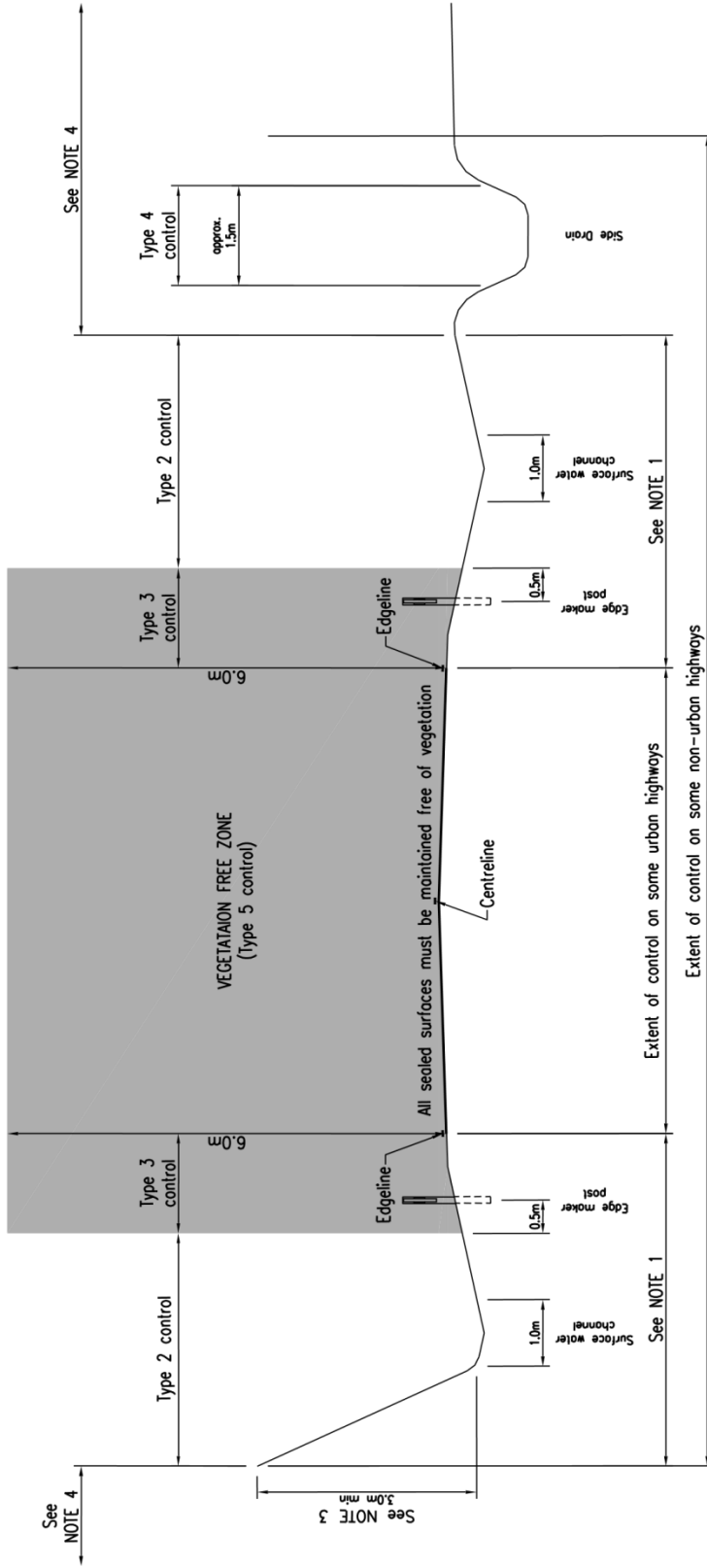

- NOTE 1 this distance must be a minimum of 3.0m on straights and on the outside of curves and a minimum of 5.0m on the inside of curves.
- NOTE 2 Vegetation free zone must be maintained free of all vegetation.
- NOTE 3 A minimum of 3m to be maintained on the cuts up, and 2m on slope down.
- NOTE 4 These areas must be maintained according to the local requirements

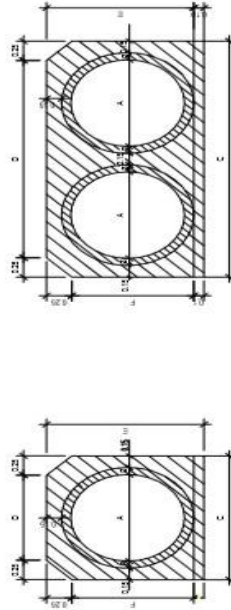
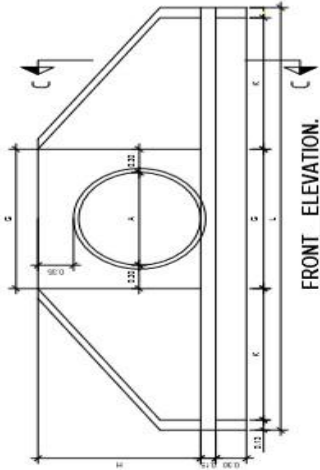

SECTION B-B.

SECTION B-B.

CULVERT	A	B	C	D	E	F	G	H	J	K	L	M	N	P	CONCRETE CLASS 25/20 INLET AND OUTLET.	CONCRETE CLASS 15/20 SURROUNDING & BEAM PER RUNNING METRE.	A193 FABRIC MESH REINFORCEMENT CLASS 15/20 MESH PER M ²
1x4.6m DIA.	0.64	0.95	1.08	0.50	0.95	0.60	1.20	1.0	1.65	0.95	3.36	1.91	2.0	1.37	2.696	0.593	22.66
2x4.6m DIA.	2x0.64	0.95	1.85	1.95	0.95	0.60	2.05	0.95	1.70	1.00	4.31	1.97	2.06	2.23	2.56	0.93	17.90
1x4.9m DIA.	0.90	0.07	1.38	0.88	1.33	0.98	1.58	1.25	1.70	0.88	3.72	1.96	2.05	1.07	3.531	0.857	28.20
1x120m DIA.	12	0.09	1.70	1.20	1.65	1.30	1.60	1.55	2.90	1.67	5.41	3.35	3.44	1.97	7.892	1.204	42.05
2x120m DIA.	2x120	0.09	3.21	2.71	1.73	1.33	3.33	1.60	3.00	1.70	6.99	3.45	3.54	3.51	8.11	2.49	54.05
2x4.9m DIA.	2x0.90	0.07	2.53	2.35	1.79	0.94	2.83	1.37	2.3	1.3	5.69	2.64	2.73	3.09	5.70	1.50	36.38

NOTES.

- A193 Fabric mesh reinforcement to B.S. 4483 to be placed as shown.
- Level and slope of the pipe shall be as instructed by the Engineer on site.
- All dimensions are in metres unless otherwise stated.
- Min. concrete surround for 12m pipe will be 200 and for slab 150mm and not 150mm and 100mm as shown in section B-B.
- 600mm culverts to be used only at intersections with township roads and minor accesses.
- Cover to BRC mesh to be 50mm.
- PCC Pipes to be manufactured in compliance with section 71 of standard specification for the road and bridge construction - 1986.
- All excavations for foundation to be approved by the Engineer on site before commencement of concrete work for each foundation.
- CONCRETE CLASS 15/20 CONCRETE BEDDING, SURROUND AND HAUNCHES.
- 25/20 CONCRETE APRONS, HEADWALLS, TOE WALLS & WINGWALLS.

ISSUED BY: ALE
REVISION BY: ALE
DATE: 10/02/2018

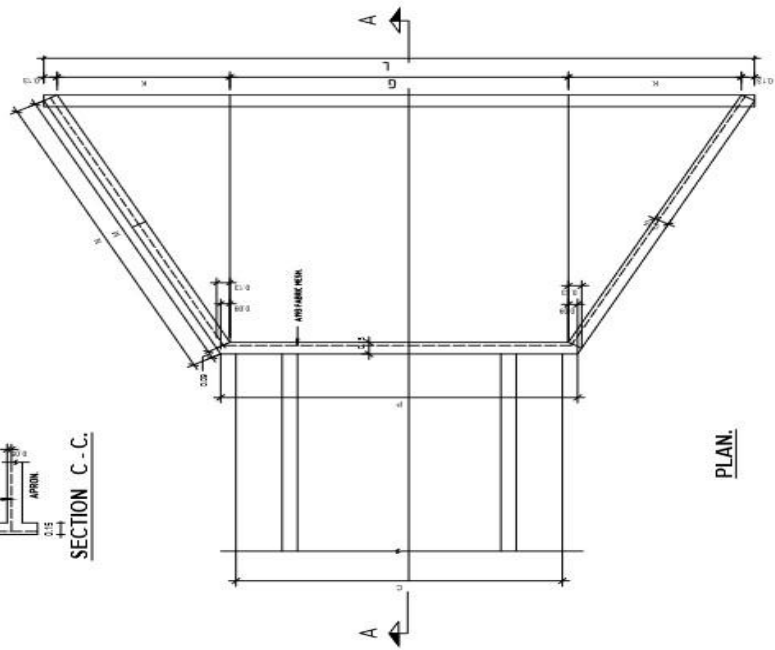
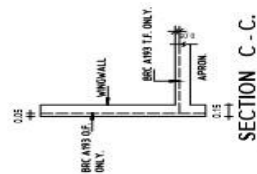
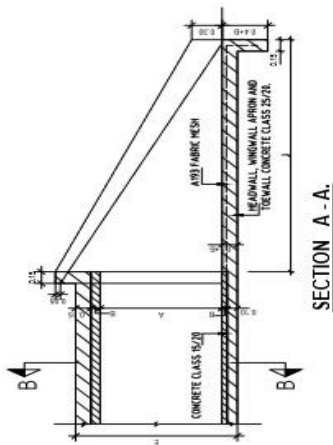

CONDITIONS OF CONTRACT PART I – GENERAL CONDITIONS OF CONTRACT

The Conditions of Contract Part 1 – General Conditions shall be those forming Part 1 of the Conditions of Contract for works of Civil engineering construction second Edition 2017, an update of the FIDIC 1999 Conditions of Contract for Construction (Red Book), First Edition, prepared by the Federation Internationale des Ingenieurs Conseils (FIDIC)

Copies of the FIDIC Conditions of Contract can be obtained from:

FIDIC Secretariat

P.O. Box 86

1000 Lausanne 12

Switzerland

Fax: 41 21 653 5432

Telephone: 41 21 653 5003

CONDITIONS OF CONTRACT PART II (CONDITIONS OF PARTICULAR APPLICATION)**SUBCLAUSE 1.1 – DEFINITIONS**

For the purpose of the Contract Documents the words and expressions below shall have the following meanings:

Amend this sub-clause 1.1.31 as follows:

The “Employer” is the County Government of Bungoma, represented by the CECM – Roads, Infrastructure and Public Works.

Amend this sub-clause 1.1.35 as follows:

The “Engineer” is the Chief Officer – Roads, Infrastructure and Public Works.

Amend this sub-clause 1.1.36 as follows:

The “Engineer Representative” is the Works Officer or Assistant Engineer in charge of the programme.

Amend this sub-clause 1.1.41 as follows:

The “Laws” means Laws of Kenya

Amend this sub-clause 1.1.10 as follows:

"Contract" means the written agreement between the Employer and the Contractor, to which these General Conditions are annexed.

Amend this sub-clause 1.1.87 as follows:

"The Works" means the works to be executed and completed under the Contract.

Amend this sub-clause 1.1.80 as follows:

"Temporary Works" shall include items to be constructed which are not intended to be permanent and form part of the Works.

Amend this sub-clause 1.1.30 as follows:

"Drawings" and "Specifications" mean the Drawings and Specifications referred to in the Contract and any modification thereof or addition thereto furnished by the Engineer or submitted by the Contractor and approved in writing by the Engineer in accordance with the Contract.

Amend this sub-clause 1.1.15 as follows:

"Bill of Quantities" is the document in which the Contractor indicates the cost of the Works, on the basis of the foreseen quantities of items of work and the fixed unit prices applicable to them.

Amend this sub-clause 1.1.13 as follows:

"Contract Price" means the sum agreed in the Contract as payable to the Contractor for the execution and completion of the Works and for remedying of any defects therein in accordance with the Contract.

"Site" means the land and other places on, under, in or through which the Works or Temporary Works are to be constructed.

SUBCLAUSE 1.4 - INTERPRETATION

Words importing persons or parties shall include firms or companies and words importing the singular only shall also include the plural and vice versa where the context requires.

SUBCLAUSE 1.4 - LANGUAGE AND LAW

The Contract document shall be drawn up in the **ENGLISH LANGUAGE**. Communication between the Contractor and the Engineer's Representative shall be in this given language. The Laws applicable to this Contract shall be the Laws of the Republic of Kenya.

SUBCLAUSE 1.5 – PRIORITY OF CONTRACT DOCUMENTS

Delete the documents listed 1- 11 and substitute: (

- 1) The Contract Agreement (if completed)
- 2) The Letter of Acceptance;
- 3) The form of Bid and Appendix to form of Bid;
- 4) The Conditions of Contract Part II;
- 5) The Conditions of Contract Part I;
- 6) The Special Specifications;
- 7) The Standard Specification for Road and Bridge Construction, 1986;
- 8) The Drawings;
- 9) The priced Bills of Quantities
- 10) other documents as listed in the Appendix to form of Bid

SUBCLAUSE 3.2 - ENGINEER'S DUTIES AND AUTHORITY.

- a) The Engineer shall provide administration of Contract as provided in the Contract Documents. In particular, he shall perform the functions hereinafter described.
- b) The Engineer shall be the Employer's representative vis-à-vis the Contractor during construction and until final payment is due. The Engineer shall advise and consult with

the Employer. The Employer's instructions to the Contractor shall be forwarded through the Engineer. The Engineer shall have authority to act on behalf of the Employer only to the extent provided in the Contract Documents as they may be amended in writing in accordance with the Contract. The duties, responsibilities and limitations of authority of the Engineer as the Employer's representative during construction as set forth in the Contract shall not be modified or extended without the written consent of the Employer, the Contractor and the Engineer.

- c) The Engineer shall visit the Site at intervals appropriate to the stage of construction to familiarize himself generally with the progress and quality of the Works and to determine in general if the Works are proceeding in accordance with the Contract Documents. On the basis of his on-site observations as an Engineer, he shall keep the Employer informed of the progress of the Works.
- d) The Engineer shall not be responsible for and will not have control or charge of construction means, methods, techniques, sequences or procedures, or for safety precautions and programs in connection with the Works or the Temporary Works. The Engineer shall not be responsible for or have control or charge over the acts or omissions of the Contractor (including the Contractor's failure to carry out the Works in accordance with the Contract) and of Sub-contractors or any of their agents or employees, or any other persons performing services for the Works, except if such acts or omissions are caused by the Engineer's failure to perform his functions in accordance with the contract between the Employer and the Engineer.
- e)) The Engineer shall at all times have access to the Works wherever and whether in preparation or progress. The Contractor shall provide facilities for such access so that the Engineer may perform his functions under the Contract.
- f) Based on the Engineer's observations and an evaluation of the documentation submitted by the Contractor together with the invoices, the Engineer shall determine the amounts owed to the Contractor and shall issue Certificates for Payment as appropriate.
- g) The Engineer shall review and approve or take other appropriate action upon the Contractor's submittals such as Shop Drawings, Product Data and Samples, but only for conformity with the design concept of the Works and with the provisions of the Contract Documents. Such action shall be taken with reasonable promptness so as to cause no delay. The Engineer's approval of a specific item shall not indicate approval of an assembly of which the item is a component.
- h) The Engineer shall interpret the requirements of the Contract Documents and judge the performance thereunder by the Contractor. All interpretations and orders of the Engineer shall be consistent with the intent of and reasonably inferable from the Contract Documents and shall be in writing or in the form of drawings. Either party may make a written request to the Engineer for such interpretation. The Engineer shall render the

interpretation necessary for the proper execution of the Works with reasonable promptness and in accordance with any time limit agreed upon. Any claim or dispute arising from the interpretation of the Contract Documents by the Engineer or relating to the execution or progress of the Works shall be settled as provided in Clause 71 of these General Conditions.

- i) Except as otherwise provided in the Contract, the Engineer shall have no authority to relieve the Contractor of any of his obligations under the Contract nor to order any work involving delay in completion of the Works or any extra payment to the Contractor by the Employer, or to make any variations to the Works.
- j) In the event of termination of the employment of the Engineer, the Employer shall appoint another suitable professional to perform the Engineer's duties.
- k) The Engineer shall have authority to reject work which does not conform to the Contract Documents. Whenever, in his opinion, he considers it necessary or advisable for the implementation of the intent of the Contract Documents, he will have authority to require special inspection or testing of the work whether or not such work be then fabricated, installed or completed. However, neither the Engineer's authority to act nor any reasonable decision made by him in good faith either to exercise or not to exercise such authority shall give rise to any duty or responsibility of the Engineer to the Contractor, any subcontractor, any of their agents or employees, or any other person performing services for the Works.
- l) The Engineer shall conduct inspections to determine the dates of Substantial Completion and Final Completion, shall receive and forward to the Employer for the Employer's review written warranties and related documents required by the Contract and assembled by the Contractor, and shall issue a final Certificate for Payment upon compliance with the requirements of Clause 47 hereof and in accordance with the Contract.
- m) If the Employer and Engineer so agree, the Engineer shall provide one or more Engineer's Representative(s) to assist the Engineer in carrying out his responsibilities at the site. The Engineer shall notify in writing to the Contractor and the Employer the duties, responsibilities and limitations of authority of any such Engineer's Representative(s).

SUBCLAUSE 4.2 - PERFORMANCE SECURITY

Replace the text of Sub-clause 4.2 with the following:

“The Contractor shall provide security for his proper performance of the Contract within 14 days after receipt of the Letter of Acceptance and must be valid up to twenty-eight days after issuance by the Engineer of the Certificate of Final Completion. The Performance Security shall be in the form of a bank guarantee as stipulated by the Employer in the Appendix to Bid. The Performance Security shall be issued by a bank incorporated in Kenya.

The Contractor shall notify the Engineer when providing the Performance Security to the Employer.

ADD NEW SUBCLAUSE;**SUBCLAUSE 4.2.4 - COST OF PERFORMANCE SECURITY**

The cost of complying with the requirements of this clause shall be borne by the Contractor.

SUBCLAUSE 4.3 - CONTRACTOR'S REPRESENTATIVE

Add the following at the end of the first paragraph of sub-clause 4.3: "The Contractor shall, within Fourteen (14) days of receipt of the Engineer's order to commence the works inform the Engineer in writing the name of the Contractor's Representative and the anticipated date of his arrival on site. The Contractor shall also submit a specimen signature of his proposed Site Agent /Road Manager who **SHALL** be the only signatory to payment of certificates/Monthly statements from the Contractor."

Add the following Sub-clause 4.3.1

**'SUBCLAUSE 4.3.1- LANGUAGE ABILITY AND QUALIFICATIONS OF
CONTRACTOR'S AUTHORISED AGENT**

Unless otherwise stated in the tender document, the Contractor's Agent or Representative on the site shall have a minimum qualification of a Diploma in Civil/Highway Engineering and shall be able to read and write English fluently. The Contractor's Agent or Representative shall have at least 5 years' relevant experience as a Site Agent or equivalent.

**ADD THE FOLLOWING SUB-CLAUSE 'SUBCLAUSE 4.3.2 - QUALIFICATION AND
LANGUAGE ABILITY OF SUPERINTENDING STAFF**

Unless otherwise stated in the Tender document, the Contractor's superintending staff shall meet the following minimum qualifications: Should have a working knowledge of English or Kiswahili. Should any of the superintending staff not be able to meet this condition, the Contractor shall propose to the Engineer arrangements for provision of a sufficient number of interpreters of approved qualifications. The Engineer, at his discretion, may amend, approve or reject such arrangements or reject deployment of superintending staff not meeting the language requirements. The Engineer may at any time during the duration of the Contract amend any approved arrangements made for interpreters, which shall be implemented at the Contractors expense.

The key staff listed below must have academic qualifications from government-recognized institutions or equivalent institutions of the levels set out in Section 5, Part 6.

- Site Agent /Road Manager

Qualifications as above shall be subject to verification and approval on site by the Engineer or his representative on site before commencement of the said works.’

SUB CLAUSE 4.10 - INSPECTION OF SITE

The Contractor shall be deemed to have inspected and examined the site and its surroundings and to have satisfied himself before submitting his Tender and signing the Contract as to all matters relative to the nature of the land and subsoil, the form and nature of the Site, details and levels of existing pipe lines, conduits, sewers, drains, cables or other existing services, the quantities and nature of the work and materials necessary for the completion of the Works, the means of access to the Site, and the accommodation he may require, and in general to have himself obtained all necessary information as to risk contingencies, climatic, hydrological and natural conditions and other circumstances which may influence or affect his Tender, and no claims will be entertained in this connection against the Employer. The Employer in no way guarantees completeness nor accuracy of the soil, materials, subsurface and hydrological information made available to the Contractor at the time of bidding or at any other time during the period of the Contract.

SUB CLAUSE 4.11 - SUFFICIENCY OF TENDER

The Contractor shall be deemed to have satisfied himself before tendering as to the correctness and sufficiency of his Tender for the construction of the Works and of the rates and prices, which rates and prices shall, except in so far as it is otherwise provided in the Contract, cover all his obligations under the Contract and all matters and things necessary for the proper execution and completion of the Works.

SUBCLAUSE 4.13.1 – INTERFERENCE WITH TRAFFIC

Supplement Sub-Clause 4.13 by adding the following sub clause 4.13.1: “The Contractor will be permitted to use existing public roads for access to the site. The Contractor shall pay vehicle license tax and road maintenance duty in accordance with relevant regulations and shall obtain any necessary permits or licenses from relevant authorities for transporting his equipment.”

Add the following sub clause 4.14.1:

SUBCLAUSE 4.14.2 – REINSTATEMENT AND COMPENSATION FOR DAMAGES TO PERSONS AND PROPERTY

The Contractor shall reinstate all properties whether public or private which are damaged in consequence of the construction and, maintenance of the works to a condition as specified and at least equal to that prevailing before his first entry on them.

If in the opinion of the Engineer the Contractor shall have failed to take reasonable and prompt action to discharge his obligations in the matter of reinstatement, the Engineer will inform the Contractor in writing of his opinion, in which circumstances the Employer reserves the right to employ others to do the necessary work of reinstatement and to deduct the cost thereof from any money due or which shall become due to the Contractor. The Contractor shall refer to the

Employer without delay all claims which may be considered to fall within the provisions of Clause 17.4.

SUBCLAUSE 4.17 – CONTRACTOR’S EQUIPMENT, TEMPORARY WORKS AND MATERIALS:

Add “The Contractor shall be at liberty to deliver and withdraw equipment as and when needed for the undertaking of works under this contract according to the equipment deployment schedule and work program approved. If a particular equipment is required and the contractor is unable at the required time to avail the said equipment, the contractor shall be expected to notify the Engineer of the possible reasons and adjustments made to such delays.

No Provisions shall be made for any claims on Idle Equipment.

SUBCLAUSE 4.18 - PROTECTION OF THE ENVIRONMENT

Add Paragraph (d) of Sub-Clause 4.18 as follows: Notwithstanding the Contractor’s obligation under Sub-Clause-paragraph (a), (b) and (c) of Sub-Clause 4.18 of the Conditions of Contract, the Contractor shall observe the following measures with a view to reducing or elimination adverse environmental effects by the site works:

- i. All quarries and borrow pits shall be filled and landscaped to their original state after extraction of construction material
- ii. Soil erosion due to surface runoff or water from culverts or other drainage structures should be avoided by putting in place proper erosion control measures that shall include, but are not limited to grassing and planting if trees
- iii. Long traffic diversion roads shall be avoided so as to minimize the effect of dust on the surrounding environment. In any case all diversions shall be kept damp and dust free
- iv. Spillage of oils, fuels and lubricants shall be avoided and if spilt, shall be collected and disposed off in such a way as not to adversely affect the environment
- v. Rock blasting near settlement areas shall be properly coordinated with the relevant officers of the Government so as to minimize noise pollution and community interference.

SUBCLAUSE 4.8 – ROYALTIES

Add at the end of this Sub-Clause the following sentence: “The Contractor shall also be liable for all payments or compensation if any that are levied in connection with the dumping of part or all of any such material.” Add The Contractor shall be solely responsible for any Cess and any other fees that the County/Region May levy on materials, goods or transportation within the Region

5.0 ASSIGNMENT AND SUBCONTRACTING**a) Assignment of Contract**

The Contractor shall not, except after obtaining the prior written approval of the Employer, assign, transfer, pledge or make other disposition of the Contract or any part thereof or of any of the Contractor's rights, claims or obligations under the Contract.

b) Subcontracting

In the event the Contractor requires the services of subcontractors, the Contractor shall obtain the prior written approval of the Employer for all such subcontractors. The approval of the Employer shall not relieve the Contractor of any of his obligations under the Contract, and the terms of any subcontract shall be subject to and be in conformity with the provisions of the Contract.

c) Assignment of Subcontractor's Obligations

In the event of a subcontractor having undertaken towards the Contractor in respect of the work executed or the goods, materials, Plant or services supplied by such subcontractor for the Works, any continuing obligation extending for a period exceeding that of the Defects Liability Period under the Contract, the Contractor shall at any time after the expiration of such Period, assign to the Employer, at the Employer's request and cost, the benefit of such obligation for the unexpired duration thereof.

ADD NEW SUBCLAUSE 6.1.1 – EMPLOYMENT OF LOCAL PERSONNEL

The Contractor is encouraged, to the extent practicable and reasonable, to employ staff and labour with appropriate qualifications and experience who are Kenya citizens.

SUBCLAUSE 6.2.1 – FAIR WAGES

The Contractor shall, in respect of all persons employed anywhere by him in the execution of the Contract, and further in respect of all persons employed by him otherwise than in the execution of the Contract in every factory, Workshop or place occupied or used by him for the execution of the Contract, observe and fulfil the following conditions:

- (a) The Contractor shall pay rates of wages, observe hours of labour and provide conditions of labour, housing, amenities and facilities not less favourable than those required by the latest Regulation of Wages (Building and Construction Industry) Order as of the time of bid submission, and subsequent amendments thereto, or in any wage scales, hours of work or conditions agreed by the Ministry of Labour or other Government Department in consultation with the appropriate wage fixing authority and generally recognized by other employees in the district whose general circumstances in the trade or industry in which the Contractor is engaged are similar.
- (b) In the absence of any rates of wages, hours or conditions of labour so established the Contractor shall pay rates of wages and observe hours and conditions of labour which are not less favourable than the general level of wages, hours and conditions observed by other Employers whose general circumstances in the trade or industry in which the Contractor is engaged are similar.

- (c) Where the absence of established rates of wages, hours and conditions of labour or the dissimilarity of the general circumstances in the trade of industry in which the Contractor is engaged prevent the Contractor from observing rates of wages, hours and conditions of labour ascertained under sub-paragraph (a) and (b) above the Contractor in fixing the rates of wages, hours and conditions of labour of his employees shall be guided by the advice of the Labour Department.
- (d) The Contractor shall recognize the freedom of his employees to be members of trade unions.
- (e) The Contractor shall maintain records in English of the time worked by, and the wages paid to, his employees. The Contractor shall furnish to the Engineer or Employer, if called upon to do so, such particulars of the rates, wages and conditions of labour as the Employer or Engineer may direct.
- (f) The Contractor shall at all times during the continuance of the contract display, for the information of his employees in every factory, workshop or place occupied or used by him for the execution of the Contract, a copy of this clause together with a notice setting out the general rates of wages, hours and conditions of labour of his employees.
- (g) The Contractor shall be responsible for the observance of this clause by sub-Contractors employed in the execution of the works.

SUBCLAUSE 6.2.2 – BREACH OF FAIR WAGES CLAUSE

Any Contractor or Sub-Contractor who is found to be in breach of Fair Wages Clause shall cease to be approved as a Contractor or Sub-Contractor for such period as the Permanent Secretary for the Ministry of Transport and Infrastructure may determine.

Should a claim be made to the Employer alleging the Contractor's default in payment of Fair Wages of any workman employed on the Contract and if proof thereof satisfactory to the Employer is furnished by the Labour Authority, the Employer may, failing payment by the Contractor, pay the claims out of any monies due or which may become due to the Contractor under the Contract.

SUBCLAUSE 6.4 – LABOUR STANDARDS

- (a) The Contractor shall comply with the existing local labour laws, regulations and labour standards
- (b) The Contractor shall formulate and enforce an adequate safety program with respect to all work under his contract, whether performed by the Contractor or subcontractor. The Contractor has assurance from the Employer of cooperation where the implementation of these safety measures requires joint cooperation.
- (c) Upon written request of the Employer the Contractor shall remove or replace any of his employees employed under this Contract.

Add the following Sub-Clause 6.4.1 and 6.4.2.

ADD SUBCLAUSE 6.4 .1 – COMPENSATION FOR INJURY

The Contractor shall in accordance with the Workmen's Compensation Act of the Laws of Kenya and any other regulations in force from time to time pay compensation for loss or damage suffered in consequence of any accident or injury or disease resulting from his work to any workman or other person in the employment of the Contractor or any Subcontractor.

SUBCLAUSE 6.4.2 – REPORTING OF ACCIDENTS

The Contractor shall report to the Engineer details of any accident as soon as possible after its occurrence. In the case of any fatality or serious accident, the Contractor shall, in addition, notify the Engineer immediately by the quickest available means. The Contractor shall also notify the relevant authority whenever the Laws of Kenya require such a report.

SUBCLAUSE 6.5.1 – RESTRICTION ON WORKING HOURS

If the Contractor requests permission to work by night as well as by day, then if the Engineer shall grant such permission the Contractor shall not be entitled to any additional payments for so doing. All such work at night shall be carried out without unreasonable noise or other disturbance and the Contractor shall indemnify the Employer from and against any liability for damages on account of noise or other disturbance created while or in carrying out night work and from and against all claims, demands, proceedings, costs, charges and expenses whatsoever in regard or in relation to such liability.

In addition, the Contractor will be required to provide, for any work carried out at night or recognized days of rest, adequate lighting and other facilities so that the work is carried out safely and properly. "In the event of the Engineer granting permission to the Contractor to work double or rotary shifts or on Sundays, the Contractor shall be required to meet any additional costs to the Employer in the administration and supervision of the Contract arising from the granting of this permission.

SUBCLAUSE 6.7 – RECORDS OF SAFETY AND HEALTH

Add the following at the end of the Sub clause: "The Contractor shall maintain such records and make such reports concerning safety, health and welfare of persons and damage to property as the Engineer may from time to time prescribe."

SUBCLAUSE 8.3 PROGRAMME

AMEND SUB CLAUSE 8.3(h) as follows:

The Contractor shall allow in his programme all published Kenya public holidays including but not limited to the following per calendar year during which the Contractor shall not be permitted to work.

- New Years Day (1st January)
- Good Friday

- Easter Monday
- Labour day (1st May)
- Madaraka Day (1st June)
- The month of Ramadhan
- IddUIFitr
- Mashujaa Day (20th October)
- Jamhuri day (12th December)
- Christmas Day (25th December)
- Boxing day (26th December)

The Contractor shall also allow per calendar year for a further 2 unspecified public holidays which may be announced by the Government of Kenya with no prior notification upon which he shall not be permitted to work.

SUBCLAUSE 8.3 - PROGRAMME

Add at the end of the last paragraph; ‘Failure by the Contractor to submit the Revised Work Program in the prescribed format and within the stipulated period shall be considered a violation of his contractual obligations and a Notice for Termination shall be issued to the Contractor.’

ADD NEW SUBCLAUSE 8.3.1- CASHFLOW ESTIMATE

The time within which the detailed cash flow estimate shall be submitted shall be as specified in the Appendix to the Form of Bid.

SUBCLAUSE 8.5 – EXTENSION OF TIME FOR COMPLETION

Add at the end of Sub-Clause 8.5 (c) the following: “Neither rains falling within the rainy seasons as occurs in Kenya nor floods caused by such rains shall be deemed exceptional weather conditions such as may fairly entitle the Contractor to an extension of time for the completion of the work.”

SUBCLAUSE 8.8 – REDUCTION OF LIQUIDATED DAMAGES

Add the following paragraphs at the end of this Sub-Clause: “There shall be no reduction in the amount of liquidated damages in the event that a part or a section of the Works within the Contract is certified as completed before the whole of the Works comprising that Contract.

The Employer shall pay no bonus for early completion of the Works to the Contractor. The sum stated in the Appendix to Bid as liquidated damages shall be increased by a sum equivalent to any additional amount payable by the Employer to the Contractor in respect of an increase in costs in such a period that would not have been incurred by the Contractor if the works had been completed by the due date for completion prescribed by Clause 8.3.

” Add The Employer may, without prejudice to any other method of recovery, deduct the amount of such damages from any monies due or to become due to the Contractor, and after the limit of

deduction prescribed in the Appendix to tender is reached, the Contract shall be considered due for Termination.

SUBCLAUSE 11.0 – DEFECTS LIABILITY PERIOD

Defects liability period shall start for Instructed works immediately the works are certified as Complete by the Engineer. The period of Defects liability shall be prescribed in the Appendix to the Contract.

SUBCLAUSE 11.1 – COMPLETION OF OUTSTANDING WORK AND REMEDYING DEFECTS

Add

At the time of End of Defects Liability Inspection, no defect arising from the permanent works existing shall be acceptable for taking over. The Inspection team shall verify and satisfy themselves that all the outstanding works and defects arising out of the works have been attended to sufficiently. Routine Maintenance works/PBC Works shall also be inspected at the time of End of Defects Liability Inspection and should comply to the specifications of the PBC Works.

SUBCLAUSE 12.4 – OMMISIONS OF QUANTITIES

Start the paragraph with: Items of Works described in the Bills of Quantities for which no rate or price has been entered in the Contract shall be considered as included in other rates and prices in the Contract and will not be paid for separately by the Employer. Add the following Sub-Clause 58.4:

SUBCLAUSE 13.1 – VARIATIONS

Add the following at the end of the last paragraph

No such variations in any way shall contravene the requirements of Public Procurement and Disposal Act of 2015 and the amendments thereof.

SUBCLAUSE 13.1. – VALUATION AND VARIATIONS

Add new Clause 13.1.1 No change in the unit rates or prices quoted shall be considered for items included in the schedule of Day works rates, or Provisional Sums and items, or for any item in the BOQ.

SUBCLAUSE 13.4 – PROVISIONAL ITEMS

Provisional items shall be read as Provisional Sums and shall be operated as such in accordance with Sub Clauses 13.4.

SUBCLAUSE 13.5 – DAYWORKS

Add the following at the end of Sub-Clause 13.5:

The work so ordered shall immediately become part of the works under the contract. The Contractor shall, as soon as practicable after receiving the Day works order from the Engineer undertake the necessary steps for due execution such work. Prior to commencement of any work to be done on a Dayworks basis, the Contractor shall give an advance notice to the Engineer stating the exact time of such commencement.

Add new clause 13.8 – VARIATIONS EXCEEDING 25 PERCENT

Subject to requirements of Public Procurement and Disposal Act of 2015 and the amendments thereof, variations above 25 percent critical to the proper function of the completed works and without which part or whole of already specified work in the bill of quantities cannot be adequately executed may constitute ground for Contract termination by either parties. In which case, the Engineer shall give 28-day notice to the Contractor with a copy to the Employer of such occurrence. The Contract shall terminate at the expiry of the notice.

SUBCLAUSE 14.15 – CURRENCY OF PAYMENT

The Contract Price shall be designated in Kenyan Currency. All work performed by the Contractor under the Contract shall be valued in Kenya Shillings using the rates and prices entered in the Bills of Quantities together with such other increases to the Contract Price, except for variation of price payments in accordance with Clause 70.1.

SUBCLAUSE 14.2.1 – ADVANCE PAYMENT

- (a) “At the request of the Contractor, The Employer MAY make an interest free advance payment to the contractor for the cost of mobilization in respect of the Works, in a lump sum of any amount not exceeding ten (10) percent of the Contract Price named in the Letter of Acceptance and Letter of Award. Non-Payment or delayed payment of the Advance shall not be a cause for any claim whatsoever.
- The Contractor is expected to have adequate financial resources to mobilise and execute the works with due diligence without the advance payment being made. Payment of such advance amount will be due under a separate certification by the Engineer after:
- i. Provision by the Contractor of the Performance Security in accordance with Clause 10 of the Conditions of Contract, and
 - ii. Provision by the Contractor of a Bank Guarantee which shall remain effective until the advance payment has been completely repaid by the Contractor out of current earnings under the Contract and certified accordingly by the Engineer. (
- (b) A form of Bank guarantee acceptable to the Employer is included in the Tender Documents. The advance payment shall be used by the Contractor exclusively for mobilization expenditures, in connection with the works. The advance payment shall not be subject to retention money.
- (c) The advance payment shall be repaid with percentage reductions from the monthly interim payments certified by the Engineer. The reimbursement of the lump sum advance payment shall be made by deductions from the interim payments and where applicable

from the balance owing to the contractor. Reimbursement shall begin when the amount of the sums due under the Contract reaches 20% of the original contract sum. It shall have been completed by the time 80% of the contract sum is reached.

- (d) The amount to be repaid by way of successive deductions shall be calculated by the means of the formula:

$$RI = A(x-X) / (80\%-20\%)$$

Where: RI = the amount to be reimbursed.

A = the amount of the advance which has been granted.

x = the amount of proposed cumulative payments as a percentage of the original amount of the contract.

This figure will exceed 20% but not 80%. X = the amount of the previous cumulative payments as a percentage of the original amount of the Contract.

This figure will be below 80% but not less than 20%. (e) With each reimbursement the guarantee will be reduced accordingly.

SUBCLAUSE 14.5 MATERIALS FOR PERMANENT WORKS

With respect to materials brought by the Contractor to the site for incorporation into the permanent works, the Contractor shall,

- Receive a credit in the month in which these materials are brought to site,
- Be charged a debit in the month in which these materials are incorporated in the permanent works.

Both such credit and debit to be determined by the Engineer in accordance with the following provisions. No credit shall be given unless the following conditions shall have been met to the Engineers Satisfaction The materials are in accordance with the specifications for the works;

- a) The materials have been delivered to site and are properly stored and protected against loss, damage or deterioration;
- b) The Contractors record of the requirements, orders receipts and use of materials are kept in a form approved by the Engineer, and such records are available for inspection by the Engineer;
- c) The Contractor has submitted a statement of his cost of acquiring and delivering the materials and plant to the Site, together with such documents as may be required for the purpose of evidencing such cost;
- d) The materials are to be used within a reasonable time.

The amount to be credited to the Contractor shall not be more than 75% of the Contractor's reasonable cost of the materials delivered to site, as determined by the Engineer after review of the documents listed in subparagraphs (a) (iv) above; The amount to be debited to the Contractor for any materials incorporated into the works shall be equivalent to the credit previously granted to the Contractor for such materials pursuant to Clause (b) above as determined by the Engineer.

SUBCLAUSE 19.2 - INSURANCE TO BE PROVIDED BY THE CONTRACTOR

Without limiting his obligations and responsibilities, the Contractor shall insure immediately following signature of this Contract, in the joint names of the Employer and the Contractor (a) for the contract period against all loss or damage from whatever cause arising, other than cause of Force majeure as defined in clause 66 of these General Conditions, and (b) against loss or damage for which the Contractor is responsible, in such manner that the Employer and the Contractor are covered for the contract period stipulated and are also covered during the Defects Liability Period for loss or damage arising from a cause occurring prior to the commencement of the Defects Liability Period and for any loss or damage occasioned by the Contractor in the course of any operations carried out by him for the purpose of complying with his obligations under Clause 47 hereof:

- a) The Works, together with the materials and Plant for incorporation therein, to their full replacement cost, plus an additional sum of ten (10) per cent of such replacement cost, to cover any additional costs of and incidental to the rectification of loss or damage including professional fees and the cost of demolishing and removing any part of the Works and of removing debris of whatsoever nature;
- b) The Contractor's equipment and other things brought on to the Site by the Contractor to the replacement value of such equipment and other things;
- c) An insurance to cover the liabilities and warranties of Section 52(4); Such insurance shall be effected with an insurer and in terms approved by the Employer, which approval shall not be unreasonably withheld, and the Contractor shall, whenever required, produce to the Engineer the policy or policies of insurance and the receipts for payment of the current premiums.

19.2.1 DAMAGE TO PERSONS AND PROPERTY

The Contractor shall (except if and so far as the Contract provides otherwise) indemnify, hold and save harmless and defend at his own expense the Employer, its officers, agents, employees and servants from and against all suits, claims, demands, proceedings, and liability of any nature or kind, including costs and expenses, for injuries or damages to any person or any property whatsoever which may arise out of or in consequence of acts or omissions of the Contractor or its agents, employees, servants or subcontractors in the execution of the Contract. The provision of this Clause shall extend to suits, claims, demands, proceedings and liability in the nature of workmen's compensation claims and arising out of the use of patented inventions and devices. Provided always that nothing herein contained shall be deemed to render the Contractor liable for or in respect of or with respect to:

- a) The permanent use or occupation of land by the Works or any part thereof;
- b) The right of the Employer to construct the Works or any part thereof on, over, under, or through any land.

- c) Interference whether temporary or permanent with any right of light, airway or water or other easement or quasi-easement which is the unavoidable result of the construction of the Works in accordance with the Contract.
- d) Death, injuries or damage to persons or property resulting from any act or neglect of the Employer, his agents, servants or other contractors, done or committed during the validity of the Contract.

19.2.2 LIABILITY INSURANCE

a) Obligation to take out Liability Insurance

Before commencing the execution of the Works, but without limiting his obligations and responsibility under Clause 20 hereof, the Contractor shall insure against his liability for any death, material or physical damage, loss or injury which may occur to any property, including that of the Employer or to any person, including any employee of the Employer by or arising out of the execution of the Works or in the carrying out of the Contract, other than due to the matters referred to in the proviso to Clause 22 hereof.

b) Minimum Amount of Liability Insurance

Such insurance shall be effected with an insurer and in terms approved by the Employer, which approval shall not be unreasonably withheld, and for at least the amount specified in the contract. The Contractor shall, whenever required by the Employer or the Engineer, produce to the Engineer the policy or policies of insurance and the receipts for payment of the current premiums.

c) Provision to Indemnify Employer

The insurance policy shall include a provision whereby, in the event of any claim in respect of which the Contractor would be entitled to receive indemnity under the policy, being brought or made against the Employer, the insurer shall indemnify the Employer against such claims and any costs, charges and expenses in respect thereof.

19.2.3 ACCIDENT OR INJURY TO WORKMEN

- a) The Employer shall not be liable for or in respect of any damages or compensation payable at law in respect or in consequence of any accident or injury to any workman or other person in the employment of the Contractor or any sub-Contractor, save and except an accident or injury resulting from any act or default of the Employer, his agents or servants. The Contractor shall indemnify, hold and save harmless the Employer against all such damages and compensation, save and except as aforesaid, and against all claims, proceedings, costs, charges and expenses whatsoever in respect thereof or in relation thereto.
- b) Insurance Against Accident, etc., to Workmen

The Contractor shall insure against such liability with an insurer approved by the Employer, which approval shall not be unreasonably withheld, and shall continue such insurance during the whole of the time that any persons are employed by him for the Works and shall, when required, produce to the Engineer such policy of insurance and the receipt for payment of the current premium. Provided always that, in respect of any persons employed by any subcontractor, the Contractor's obligation to insure as aforesaid under this sub-clause shall be satisfied if the subcontractor shall have insured against the liability in respect of such persons in such manner that the Employer is indemnified under the policy but the Contractor shall require such subcontractor to produce to the Engineer when required such policy of insurance and the receipt for the current premium, and obtain the insertion of a provision to that effect in its contract with the subcontractor.

19.2.4 REMEDY ON CONTRACTOR'S FAILURE TO INSURE

If the Contractor shall fail to effect and keep in force any of the insurances referred to in hereof, or any other insurance which he may be required to effect under the terms of the Contract, the Employer may in any such case effect and keep in force any such insurance and pay such premium as may be necessary for that purpose and from time to time deduct the amount so paid by the Employer as aforesaid from any monies due or which may become due to the Contractor, or recover the same as a debt due from the Contractor.

ADD SUB CLAUSE 19.3 - EXCLUSIONS

“There shall be no obligation for the insurances in Sub-Clause 19.2 to include loss or damage caused by the risks listed under Sub-Clause 18.1

ADD SUB CLAUSE 19.4 – MINIMUM AMOUNT OF INSURANCE

Add the following at the end of this Clause: “with no limits to the number of occurrences”.

ADD SUBCLAUSE 19.5 – INSURANCE NOTICES

Each policy of insurance effected by the Contractor for purposes of the Contract shall include a provision to the effect that the Insurer shall have a duty to give notice in writing to the Contractor and Employer of the date when a premium becomes payable. This shall not be more than thirty (30) days before that date and the policy shall remain in force until thirty (30) days after the giving of such notice.

ADD SUBCLAUSE 19.6 – NOTIFICATION TO INSURERS

It shall be the responsibility of the Contractor to notify insurers under any of the insurance referred to in sub clauses 19.1 and 19.2 on any matter or event, which by the terms of such insurance are required to be so notified. The Contractor shall indemnify and keep indemnified the Employer against all losses, claims, demands, proceedings, costs, charges and expenses whatsoever arising out of or in consequence of any default by the Contractor in complying with

the requirements of this Sub-Clause whether as a result of avoidance of such insurance or otherwise.

SUBCLAUSE 21.1 – ADJUDICATION

Delete the entire sub clause 21.1 and add the following; “The Adjudicator shall be appointed by the Chartered Institute of Arbitrators (Kenya) unless the appointment is agreed by the parties within 7 (seven) days of the notice to adjudication. The adjudication process shall be conducted according to the Laws of Kenya and the Rules of the Chartered Institute of Arbitrators (Kenya).”

SUBCLAUSE 21.5 – AMICABLE SETTLEMENT

Delete the entire sub clause 21.3 and add the following; “Where notice to of intention to commence adjudication as to a dispute has been in accordance with sub clause 21.1, the parties shall attempt to settle such dispute in amicably before the commencement of Adjudication; provided that, unless the parties otherwise agree, Adjudication may be commenced on or after the 14th (fourteenth) day after the day on which notice of intention to commence adjudication of such dispute was given, even if an attempt at amicable settlement thereto has been made.”

SUBCLAUSE 21.6 – ARBITRATION

Delete the entire sub clause 21.6 and add the following; “Any dispute in respect of which: The decision, if any, of the Adjudicator has not become final and binding pursuant to sub clause 67.1, and Amicable settlement has not been reached within the period stated in sub clause 67.2, shall be finally settled, under the Laws of Kenya and the Arbitration Rules of the Chartered Institute of Arbitrators (Kenya Branch) by one or more arbitrators appointed by the Chartered Institute of Arbitrators (Kenya Branch). Neither party shall be limited in the in the proceedings before such arbitrator/s to the evidence or arguments put before the Adjudicator for the purpose of obtaining his said decision pursuant to sub clause 21. Arbitration may be commenced prior to or after completion of the works, provided that the obligations of the Employer, the Engineer and the Contractor shall not be altered by reason of the arbitration being conducted during the progress of the works.

CLAUSE 22 – BRIBERY AND COLLUSION**Add new Clause 22.1:**

“The Contractor shall not:

- a) Offer or give or agree to give to any person in the service of the Government of Kenya any gift or consideration or any kind as an inducement or reward for doing or forbearing to do or for having done or forborne to do any act in relation to the obtaining or execution of this or any other contract to which the Government of Kenya is a party or for showing or forbearing to show favour or disfavor to any person in relation to this or any other contract for the Government of Kenya.

- b) Enter into this or any other contract with the Government of Kenya in connection with which commission has been paid or agreed to be paid by or on his behalf or to his knowledge, unless before the contract is made particulars of any such commission and of the terms and conditions of any agreement for the payment thereof have been disclosed in writing to the Employer.

Any breach of this condition by the Contractor or by anyone employed by him or acting on his behalf (whether with or without the knowledge of the Contractor) or the commission of any offence by the Contractor or by anyone employed by him or acting on his behalf in relation to this or any other contract to which the Government of Kenya is a party shall entitle the Employer to determine the Contract and/ or to recover from the Contractor the amount or value of any such gift, consideration or commission.

Any dispute or difference of opinion arising in respect of either the interpretation, effect or application of this condition or of the amount recoverable hereunder by the Employer from the Contractor shall be decided by the Employer, whose decision shall be final and conclusive.